

# LoadLifter 7500 XL™



## Installation Guide

### Kit 57577

*Ford Super Duty*



Representative vehicle image

MN-1111 • (011907) • ERN 9234

For maximum effectiveness and safety, please read these instructions completely before proceeding with installation.

Failure to read these instructions can result in an incorrect installation.



# Load**LIFTER**7500**XL**

## Table of Contents

<b>A. Installation Diagram</b> .....	<b>2</b>
<b>B. Hardware and Tools Lists</b> .....	<b>3</b>
Hardware List .....	3
Tools List .....	3
<b>C. Introduction</b> .....	<b>4</b>
Notation Explanation .....	4
<b>D. Installing the LoadLifter 7500 XL System</b> .....	<b>5</b>
Getting Started .....	5
Installing the Upper Chassis Brackets .....	5
Air Spring and Bracket Assembly .....	7
Installing the Assemblies .....	10
Driver's (Left) Side Upper Brace Installation .....	12
Passenger's (Right) Side Upper Brace Installation .....	14
<b>E. Installing the Air Lines</b> .....	<b>16</b>
Installing the Heat Shield .....	17
<b>F. Finished Installation Photos</b> .....	<b>18</b>
<b>G. Before Operating</b> .....	<b>19</b>
Installation Checklist .....	19
Maintenance and Use Guidelines .....	19
Minimum and Maximum Pressure .....	19
<b>Limited Warranty and Return Policy</b> .....	<b>20</b>



# A. Installation Diagram

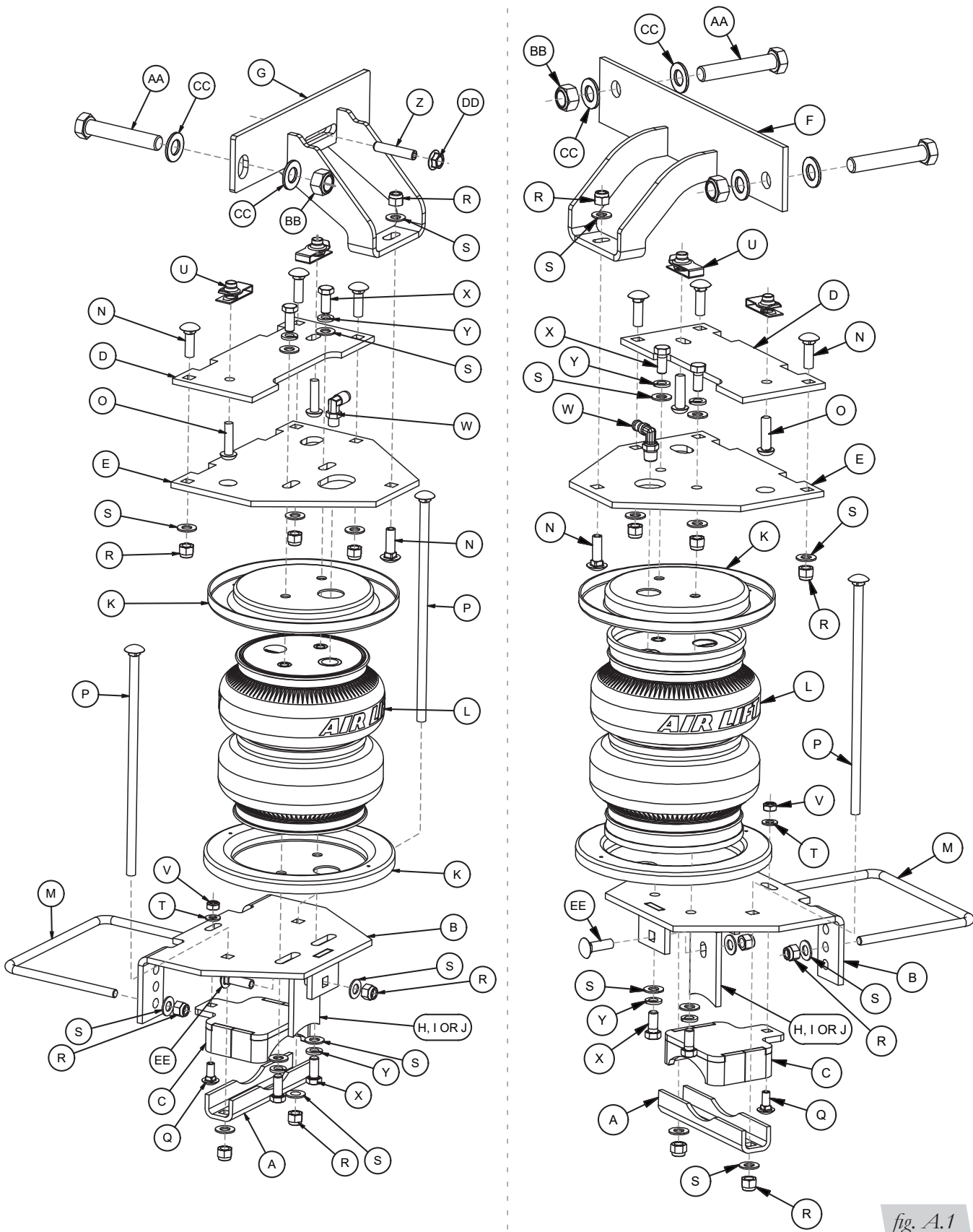


fig. A.1

# B. Hardware and Tools Lists

## HARDWARE LIST

Item	Part #	Description .....	Qty
A	01531	Clamp bar.....	2
B	03818	Lower bracket.....	2
C	03225	Lower bracket cup.....	2
D	07974	Upper chassis bracket.....	2
E	07925	Upper air spring bracket.....	2
F	07895	RH upper frame brace.....	1
G	07873	LH upper frame brace.....	1
H	03913	Lower leg adapter, 3 1/2" axle.....	2
I	03914	Lower leg adapter, 4" axle.....	2
J	03915	Lower leg adapter, 4 1/2" axle.....	2
K	11897	Roll plate.....	4
L	58115	Air spring.....	2
M	11770	U-bolt.....	2
N	17361	3/8"-16 x 1 1/4" Carriage bolt.....	10
O	17366	M10-1.5 x 35mm Button head cap screw.....	4
P	17387	3/8"-16 x 10" Carriage bolt.....	4
Q	17500	5/16"-18 x 3/4" Carriage bolt.....	2
R	18435	3/8"-16 Nylon lock nut.....	18
S	18444	3/8" Flat washer.....	27
T	18501	M8 Flat washer.....	4
U	18622	M10-1.5mm, Short universal nut.....	4
V	18613	5/16"-18 Nylon lock nut.....	2
W	21830	1/4" NPT x 1/4" PTC swivel 90-degree fitting.....	2
X	17203	3/8"-24 x 7/8" Hex bolt.....	8
Y	18427	3/8" Lock washer.....	8
Z	17525	M10 x 1.5 x 50mm Set screw.....	1
AA	17348	5/8"-11 x 4 1/2" Hex cap screw.....	3
BB	18548	5/8"-11 Nylon lock nut.....	3
CC	18449	5/8"-11 Flat washer.....	6
DD*	18651	M10 x 1.5 Serrated flange nut.....	1
EE	17134	3/8"-16 x 1 Carriage bolt.....	2
FF*	10466	Zip ties.....	6
GG*	21230	Valve cap.....	2
HH*	21234	Rubber washer.....	2
II*	18411	Small star washer.....	2
JJ*	21233	5/16" Hex nut.....	4
KK*	20086	Air line with 2 schrader valves.....	1

\*Not shown in Figure A.1

## TOOLS LIST

Description.....	Qty
Metric & standard open-end box wrenches.....	set
Ratchet with metric and standard sockets.....	set
Drill and 5/16" drill bit.....	1
Torque wrench.....	1
Hex key wrenches metric and standard.....	set
Hose cutter, razor blade or sharp knife.....	1
Hoist or floor jack.....	1
Safety stands.....	2
Safety glasses.....	1
Air compressor or compressed air source.....	1
Spray bottle with dish soap/water solution.....	1



Missing or damaged parts? Call Air Lift customer service at (800) 248-0892 for a replacement part.

# C. Introduction

The purpose of this publication is to assist with the installation and maintenance of the LoadLifter 7500 XL air spring kit. LoadLifter 7500 XL utilizes sturdy, reinforced, commercial-grade double convolute bellows. The bellows are manufactured like a tire with layers of rubber and cords that control growth. LoadLifter 7500 XL kits are recommended for most 3/4- and 1-ton pickups and SUVs with leaf springs and provide up to 7,500 pounds of load-leveling support with air adjustability from 5-100 PSI.

It is important to read and understand the entire installation guide before beginning installation or performing any maintenance, service or repair. The information here includes a hardware list, tool list, step-by-step installation information, maintenance guidelines and operating tips.

Air Lift Company reserves the right to make changes and improvements to its products and publications at any time. For the latest version of this manual, contact Air Lift Company at **(800) 248-0892** or visit **[airliftcompany.com](http://airliftcompany.com)**.

## NOTATION EXPLANATION

Hazard notations appear in various locations in this publication. Information which is highlighted by one of these notations must be observed to help minimize risk of personal injury or possible improper installation which may render the vehicle unsafe. Notes are used to help emphasize areas of procedural importance and provide helpful suggestions. The following definitions explain the use of these notations as they appear throughout this guide.



INDICATES IMMEDIATE HAZARDS WHICH WILL RESULT IN SEVERE PERSONAL INJURY OR DEATH.



INDICATES HAZARDS OR UNSAFE PRACTICES WHICH COULD RESULT IN SEVERE PERSONAL INJURY OR DEATH.



INDICATES HAZARDS OR UNSAFE PRACTICES WHICH COULD RESULT IN DAMAGE TO THE MACHINE OR MINOR PERSONAL INJURY.

---

### NOTE

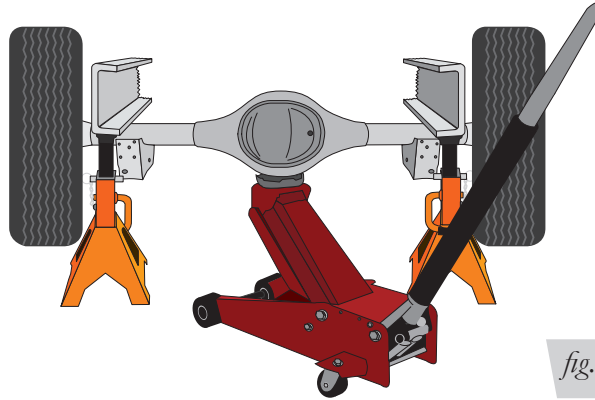
*Indicates a procedure, practice or hint which is important to highlight.*

---

## D. Installing the LoadLifter 7500 XL System

### GETTING STARTED

1. Raise the vehicle and support it in a way, using safety stands or equivalent, that the axle can be safely dropped away from the frame. This will need to be done in order for the air spring assembly to be put into position between the axle and frame (Fig. D.1).



*fig. D.1*

### INSTALLING THE UPPER CHASSIS BRACKETS

1. Unbolt and remove the jounce bumper assembly from under the frame on both sides (Fig. D.2).



*fig. D.2*

2. Remove the clip-in studs by prying on the hinged end with a screwdriver to release. Pull all four out of the frame (Fig. D.3).

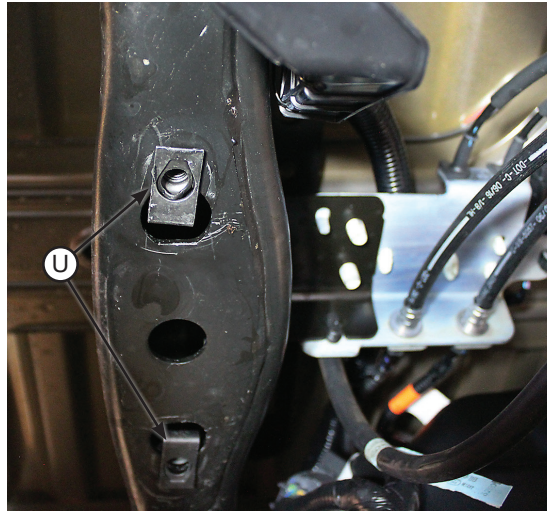


*fig. D.3*

3. Install the universal nuts (U) into the frame rail, lining up the holes in the frame and the threads in the nuts so that a bolt can be installed (Fig. D.4).

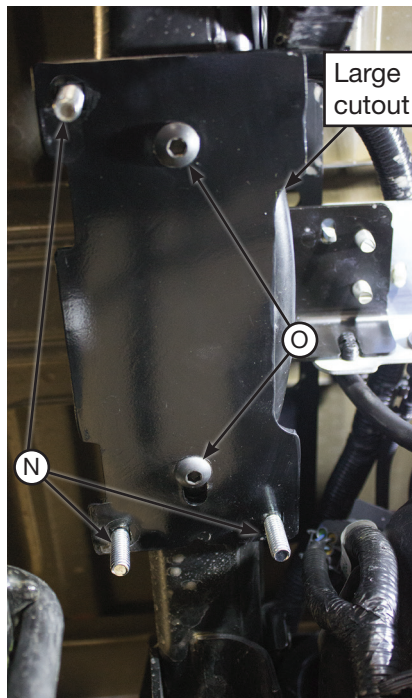
**TECH TIP**

*A flat-tipped screwdriver works well in prying the universal nut into position.*



*fig. D.4*

4. Insert the 3/8"-16 x 1 1/4" carriage bolts (N) into the upper chassis bracket (D). Install the upper chassis bracket onto the frame using the M10-1.5 x 35mm button head cap screws (O) so that the large cut-out on the side of the bracket is inboard of the frame rail and the slotted hole in the center is forward (Fig. D.5). Torque hardware to 38 lb.-ft. (52Nm).



*fig. D.5*



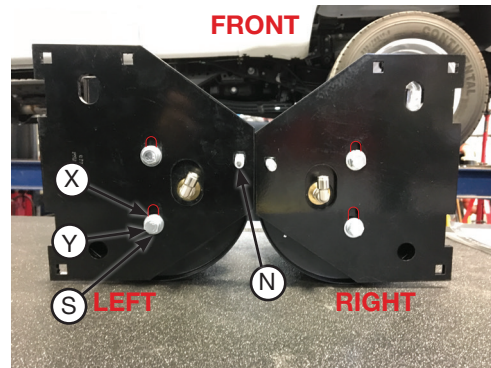
## AIR SPRING AND BRACKET ASSEMBLY

1. Install the swivel elbow fitting (W) into the top of the air spring finger-tight. Tighten the swivel fitting an additional one and a half turns. Place a roll plate (K) on top of the air spring (Fig. D.6).



*fig. D.6*

2. Insert 3/8"-16 x 1 1/4" carriage bolts (N) into the square holes on the brackets, then secure the upper air spring bracket (E) onto the top of the air springs using 3/8"-24 x 7/8" hex bolts (X), 3/8" lock washers (Y) and 3/8" flat washers (S). At this stage, the air spring assemblies are left- and right-hand units. Push the brackets as far forward as possible (Fig. D.7). Torque the hardware to no more than 20 lb.-ft. (27Nm).



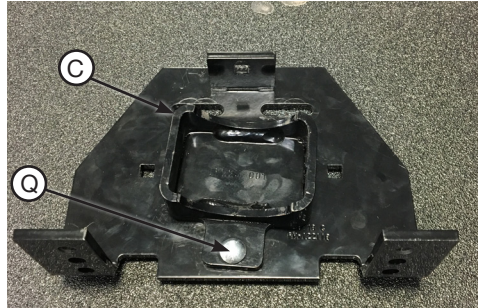
*fig. D.7*

3. Flip the assemblies over and set a roll plate onto the bottom of the air spring (Fig. D.8).

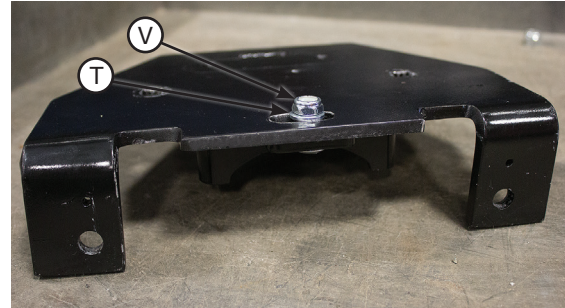


*fig. D.8*

4. Install the lower bracket cup (C) onto the lower bracket main plate using a 5/16"-18 x 3/4" carriage bolt (Q) (Fig. D.9). Cap with an M8 flat washer (T) and 5/16"-18 nylon lock nut (V) (Fig. D.10). Snug the bolt, but leave loose enough for the bracket to move freely in the slot.

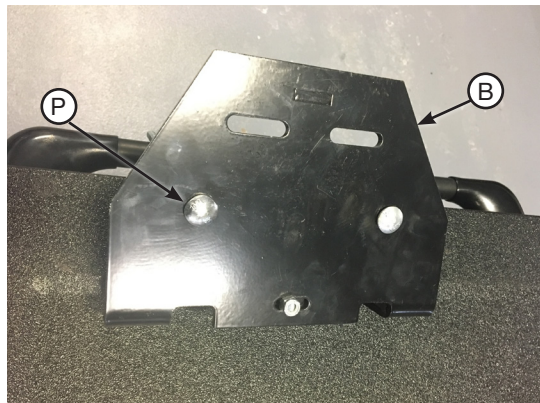


*fig. D.9*



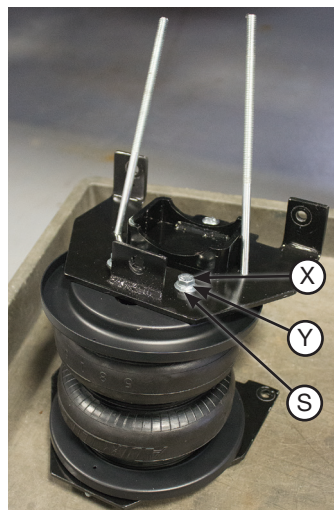
*fig. D.10*

5. Insert two 3/8"-16 x 10" carriage bolts (P) through the square holes in the lower bracket main plate (B) (Fig. D.11).

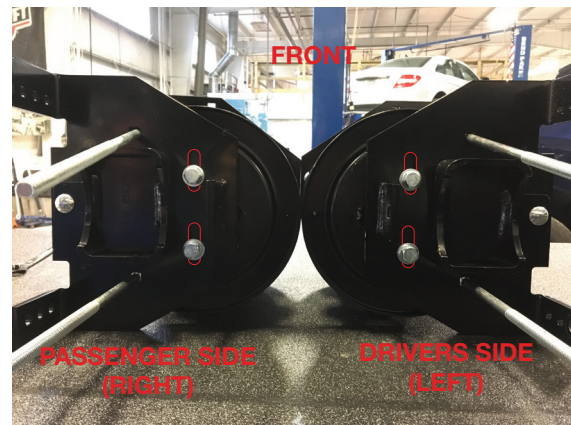


*fig. D.11*

6. Set the lower bracket assemblies onto the air spring with a roll plate installed and attach with two 3/8"-24 x 7/8" hex bolts (X), 3/8" lock washers (Y) and 3/8" flat washers (S) (Fig. D.12). Torque the hardware to no more than 20 lb.-ft. (27Nm). Push the lower bracket as far forward as possible. Refer to Figure D.13.



*fig. D.12*



*fig. D.13*

- Select the appropriate lower leg adapter for the specific vehicle. This is determined by the diameter of the axle (See Table 1). This brace will be attached with a 3/8"-16 x 1 1/4" carriage bolt (N), a nylon lock nut (R) and a flat washer (S). Torque the nylon lock nut to 10 lb.-ft. (14Nm) (Figs. D.14 & D.15).

Axle Diameter	Part #
3.5"	03913
4.0"	03914
4.5"	03915

Table 1

**NOTE**

To determine the diameter of the axle, use a tape measure to measure the circumference. Divide the circumference by pi (3.14) (diameter = circumference/3.14).

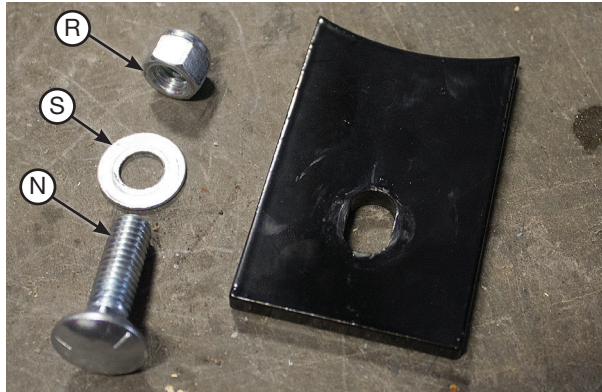


fig. D.14



fig. D.15

- Refer to Figure D.16 for the driver's (left) and passenger's (right) side assemblies.

**Driver's (left)  
side**

**Passenger's  
(right) side**



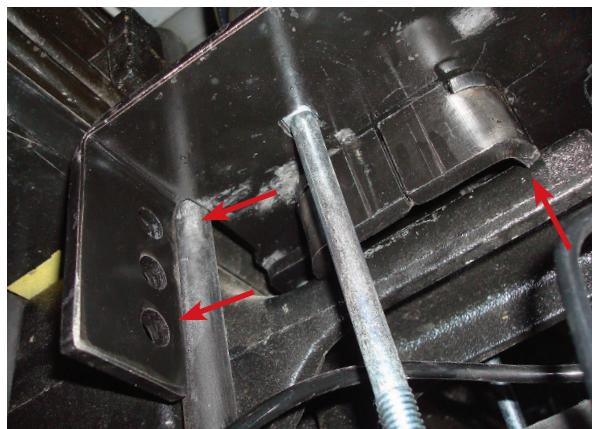
fig. D.16

## INSTALLING THE ASSEMBLIES

1. With the vehicle supported by safety stands, drop the axle or raise the body so that the assemblies can be put into position in between the axle and frame. Set the driver's (left) side and passenger's (right) side assemblies into position so that the lower bracket cup nests on the jounce bumper strike plate. Push the lower bracket so that it is flush against the leaf spring stack and both flanges on the lower bracket are locked around the stock U-bolts (Fig. D.17).

**NOTE**

*The flanges need to be oriented so that they lock around the truck's existing leaf spring U-bolts.*



*fig. D.17*

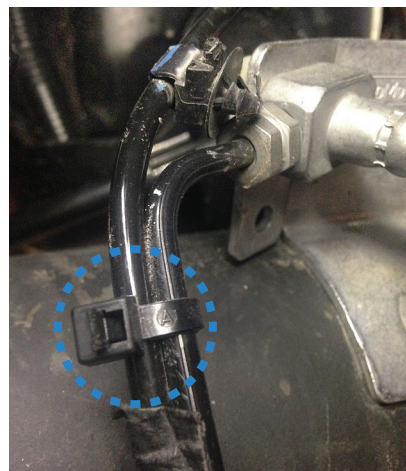
**NOTE**

*On the driver's (left) side, the long carriage bolt in the lower bracket will be between the hard brake line and axle (Fig. D.23). On the passenger's (right) side, the carriage bolt will be on the back side of the brake line (Fig. D.24).*

2. The ABS sensor line is attached to the axle via a clip on the brake line bracket (circled in red) (Fig. D.18). Remove this clip and zip tie the line to the brake hard line (blue circle) to keep it away from the lower support leg (Fig. D.19).



*fig. D.18*



*fig. D.19*

- 3 Install the U-bolts (M) around the jounce bumper strike plate/spacer blocks and insert through either set of holes in the lower bracket (Fig. D.20). Cap with the 3/8" flat washers (S) and 3/8"-16 nylon lock nuts (R). Snug the bolts evenly, just enough to hold the lower bracket flush against the stock U-bolts.

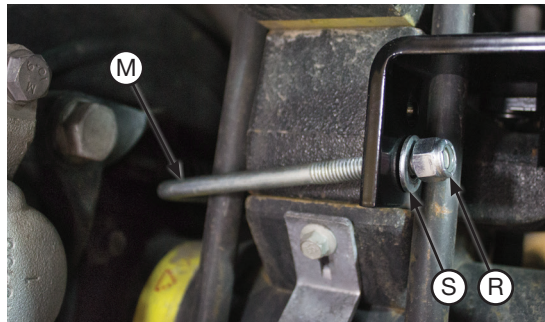


fig. D.20

- 4 Set the lower clamp bar (A) over the carriage bolts under the axle (Fig. D.21). Attach with 3/8" flat washers (S) and 3/8"-16 nylon lock nuts (R). Evenly torque the lower clamp bar hardware to 16 lb.-ft. (22Nm). Finish tightening the U-bolt hardware previously snugged by torquing to 10 lb.-ft. (14Nm).

**NOTE**

*On vehicles with anti-sway bars, it may be necessary to trim the front carriage bolt that secures the clamp bar.*

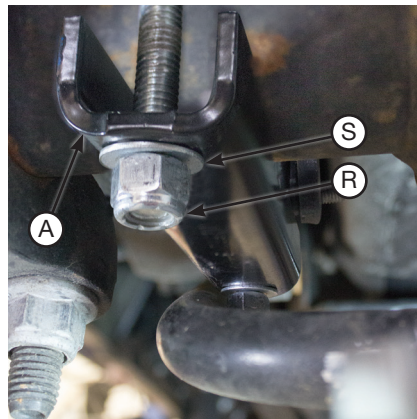


fig. D.21

- 5 Snug the nut that holds the lower bracket main plate and lower bracket cup together to finish the lower bracket installation (Fig. D.22).

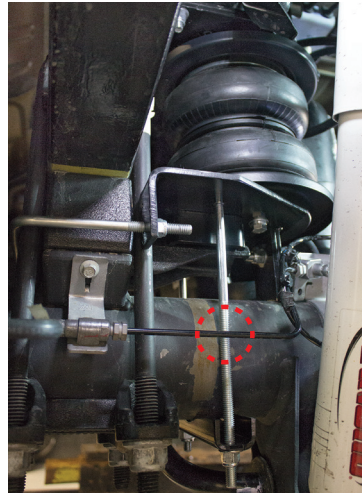
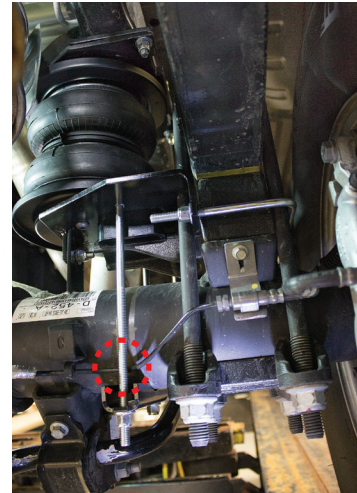
**TECH TIP**

*This nut will be difficult to tighten. It may be necessary to flip over the wrench a couple times and move to the front/back side of the axle to tighten completely.*



fig. D.22

6. Figures D.23 & D.24 show the lower bracket installed. Note the location of the carriage bolts in conjunction with the hard brake and ABS lines.

**Driver's (left) side***fig. D.23***Passenger's (right) side***fig. D.24***CAUTION**

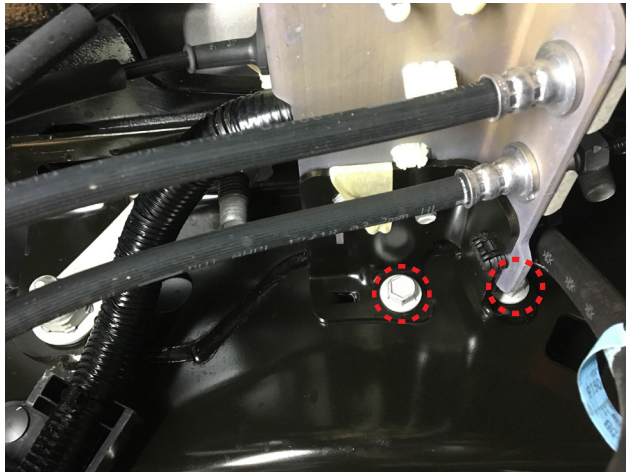
IT WILL BE NECESSARY TO PUSH THE HARD BRAKE LINE AWAY FROM THE LOWER BRACKET CARRIAGE BOLT IF THE LINE IS RESTING ON IT.

**DRIVER'S (LEFT) SIDE UPPER BRACE INSTALLATION**

1. Remove the rearward fifth wheel bracket hardware and set aside (Fig. D.25).

*fig. D.25*

2. Locate the two M10 bolts holding the brake line bracket to the frame (Fig. D.26). Unbolt both and pull the bracket away from the frame (Fig. D.27).

*fig. D.26**fig. D.27*

3. Install the included threaded stud into the rearward threaded hole. Leave about 30mm (1.20") protruding from the frame (Fig. D.28).

*fig. D.28*

4. Align upper bracket on the frame and thread the included M10 flange nut (DD) onto the stud. Put the factory fifth wheel bolt or the included 5/8" hardware (AA) through the frame and the bracket. Thread the matching nut on the bolt (Figs. D.29 & D.30). Do not fully tighten.

*fig. D.29**fig. D.30*

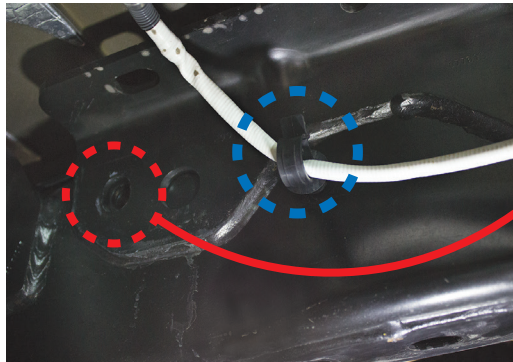
## PASSENGER'S (RIGHT) SIDE UPPER BRACE INSTALLATION

1. Locate the clip (blue circle) that holds the wiring harness for the O<sub>2</sub> sensor. Discard the clip, as it will no longer be needed (Fig. D.31).

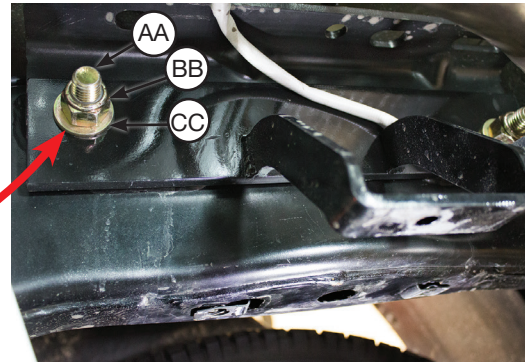
**NOTE**

*Some models may not have the O<sub>2</sub> sensor clip.*

2. Some models come equipped with a factory fifth-wheel bracket. It will be necessary to remove the hardware from these holes if the vehicle has this bracket. Find the two holes located under the factory fifth-wheel brackets. Attach the upper frame brace using the included 5/8" hex cap screws (AA), nuts (BB) and washers (CC) (Fig. D.32).

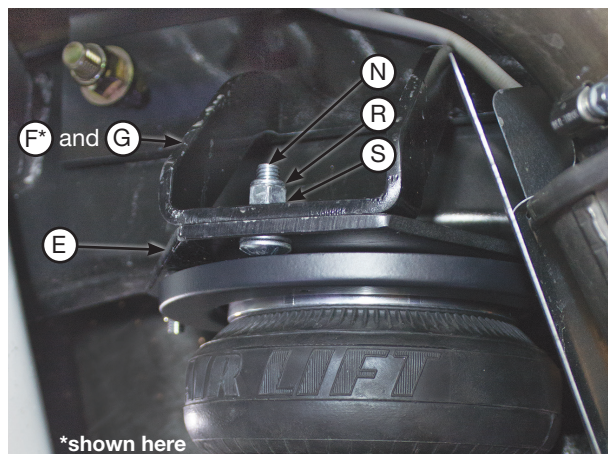


*fig. D.31*

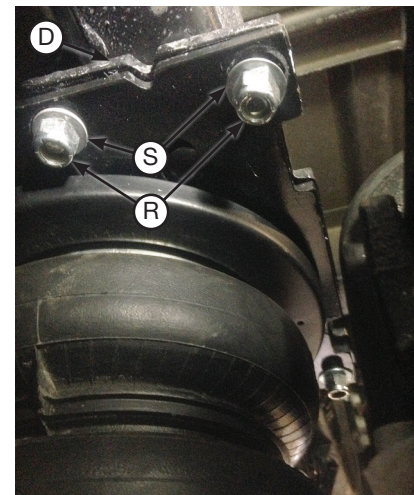


*fig. D.32*

3. Align upper air spring brackets (E) with the upper frame braces (F [shown] & G) and the upper chassis brackets (D). Secure with flat washers (S), and nylon lock nuts (R) over the carriage bolts (N) (Figs. D.33 & D.34). Do not tighten. Repeat on both sides. With all hardware hand-tight, torque all 3/8" hardware to 16 lb.-ft. Torque the fifth wheel 5/8" hardware to 150 lb.-ft. for the included hardware (AA and BB). Torque to 180 lb.-ft. for the factory bolt.



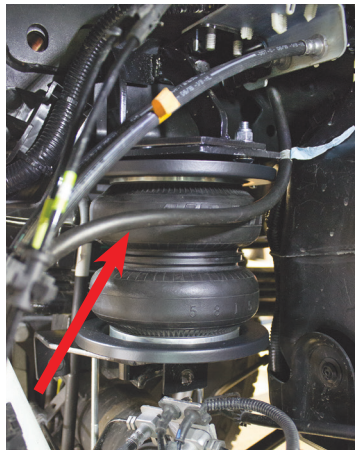
*fig. D.33*



*fig. D.34*



4. The axle vent tube will also have to be zip tied to one of the brake soft lines in order to keep it out of the way of the air spring assembly (Figs. D.35 & D.36).



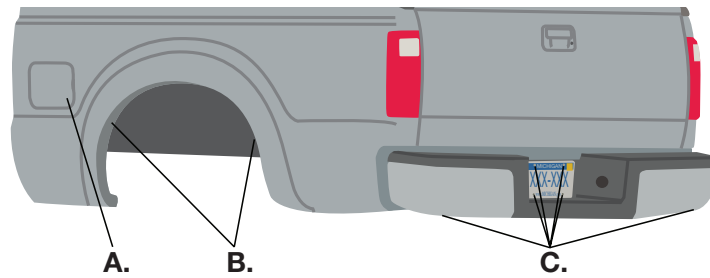
*fig. D.35*



*fig. D.36*

# E. Installing the Air Lines

Choose the locations for the Schrader valves and drill a 5/16" (8mm) hole, if necessary (Fig. E.1).



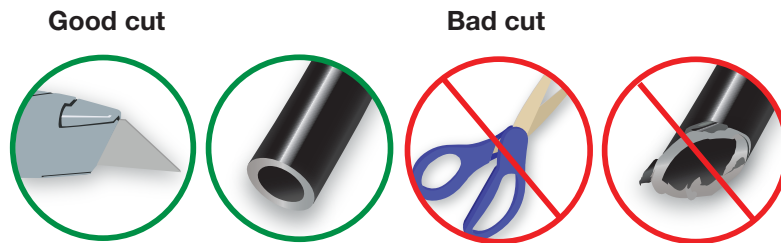
- A. Inside fuel tank filler door
- B. Inside rear wheel wells
- C. License plate or rear bumper area

*fig. E.1*

**CAUTION**

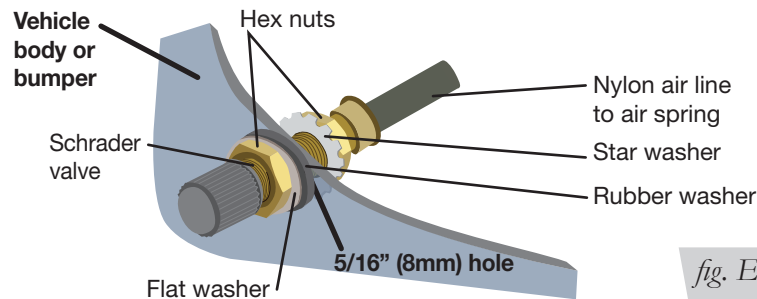
KEEP AT LEAST 6" (150MM) OF CLEARANCE BETWEEN ALL AIR LINES AND THE EXHAUST SYSTEM. AVOID SHARP BENDS AND EDGES.

1. Cut the air line in half. Make clean, square cuts with a razor blade or hose cutter (Fig. E.2). Do not use scissors or wire cutters.
2. Use zip ties (FF) to secure the air line to fixed points along the chassis. Do not pinch or kink the air line. The minimum bend radius for the air line is 1" (25mm). Leave at least 2" (50mm) of slack in the air line to allow for any movement that might pull on the air line.



*fig. E.2*

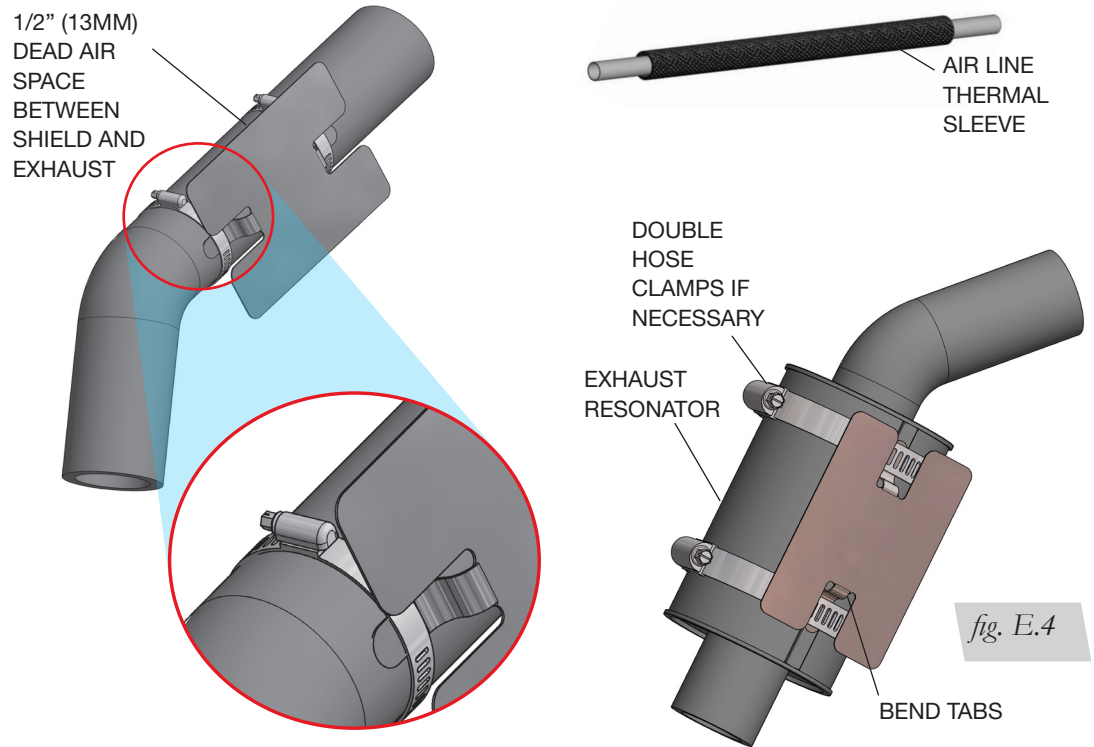
3. Install the Schrader valve in the chosen location (Fig. E.3).



*fig. E.3*

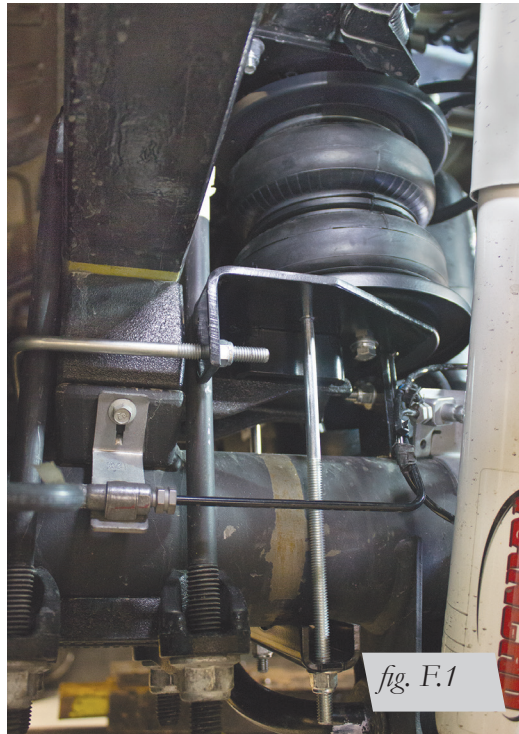
## INSTALLING THE HEAT SHIELD

1. Attach the metal heat shield to the exhaust where it is closest to the air spring. Slide the air line thermal sleeve over the air line and place it where the air line is closest to the exhaust (Fig. E.4).

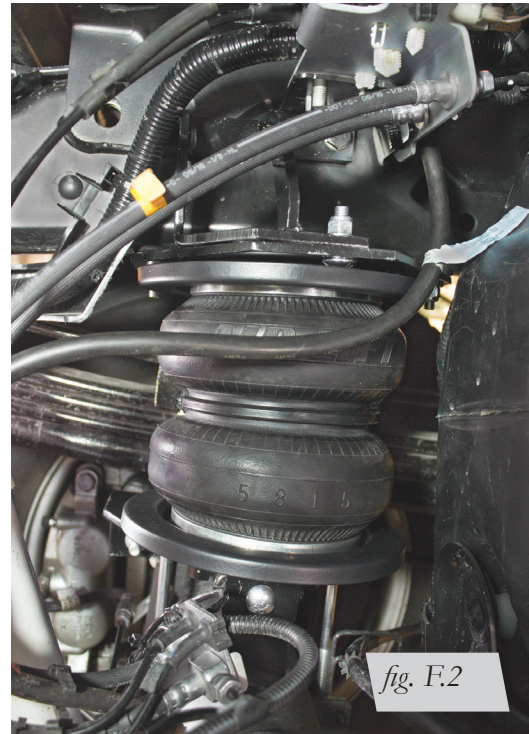


## F. Finished Installation Photos

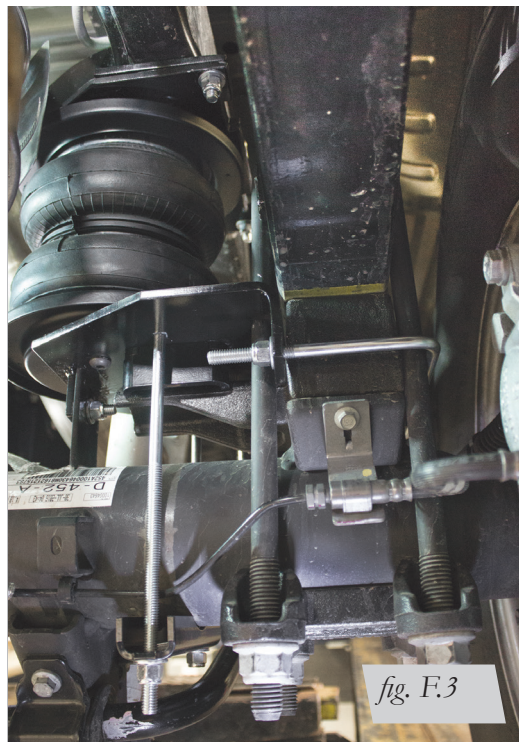
1. The following images show the finished installation of both sides (Figs. F.1, F.2, F.3 & F.4).



Left-hand installation from the rear.



Left-hand installation from the middle.



Right-hand installation from the rear.



Right-hand installation from the middle.

## G. Before Operating

### INSTALLATION CHECKLIST

- Clearance test** — Inflate the air springs to 40-60 PSI (2.8-4.1BAR) and make sure there is at least 1/2" (13mm) clearance from anything that might rub against each sleeve. Be sure to check the tire, brakes, frame, shock absorbers and brake cables.
- Leak test before road test** — Inflate the air springs to 40-60 PSI (2.8-4.1BAR) and check all connections for leaks. All leaks must be eliminated before the vehicle is road tested.
- Heat test** — Be sure there is sufficient clearance from heat sources, at least 6" (152mm) for air springs and air lines. If a heat shield was included in the kit, install it. If there is no heat shield, but one is required, call Air Lift customer service at **(800) 248-0892**.
- Fastener test** — Recheck all bolts for proper torque.
- Road test** — The vehicle should be road tested after the preceding tests. Inflate the springs to recommended driving pressures. Drive the vehicle 10 miles (16km) and recheck for clearance, loose fasteners and air leaks.
- Operating instructions** — If professionally installed, the installer should review the operating instructions with the owner. Be sure to provide the owner with all of the paperwork that came with the kit.

### MAINTENANCE AND USE GUIDELINES

1. Check air pressure weekly.
2. Always maintain normal ride height. Never inflate beyond 100 PSI (7BAR).
3. If the system develops an air leak, use a soapy water solution to check all air line connections and the inflation valve core before deflating and removing the air spring.

Minimum Recommended Pressure	Maximum Air Pressure
<b>5 PSI (.34BAR)</b>	<b>100 PSI (7BAR)</b>

 **CAUTION**

FOR SAFETY AND TO PREVENT POSSIBLE DAMAGE TO THE VEHICLE, DO NOT EXCEED MAXIMUM GROSS VEHICLE WEIGHT RATING (GVWR) OR PAYLOAD RATING, AS INDICATED BY THE VEHICLE MANUFACTURER.

 **CAUTION**

ALTHOUGH THE AIR SPRINGS ARE RATED AT A MAXIMUM INFLATION PRESSURE OF 100 PSI (7BAR), THE AIR PRESSURE ACTUALLY NEEDED IS DEPENDENT ON LOAD AND GROSS VEHICLE WEIGHT RATING.

## **Limited Warranty and Return Policy**

Air Lift Company provides a limited lifetime warranty to the original purchaser of its Load Support products, that the products will be free from defects in workmanship and materials when used on cars and trucks as specified by Air Lift Company and under normal operating conditions, subject to the requirements and exclusions set forth in the full Limited Warranty and Return Policy that is available online at [www.airliftcompany.com/warranty](http://www.airliftcompany.com/warranty).

For additional warranty information contact Air Lift Company customer service.



## Need Help?

Contact Air Lift Company customer service department by calling (800) 248-0892.

For calls from outside the USA or Canada, dial (517) 322-2144.



Printed in the USA  
JJC-0719

Thank you for purchasing Air Lift products — the professional installer's choice!

Air Lift Company • 2727 Snow Road • Lansing, MI 48917 or P.O. Box 80167 • Lansing, MI 48908-0167  
Toll Free (800) 248-0892 • Local (517) 322-2144 • Fax (517) 322-0240 • [www.airliftcompany.com](http://www.airliftcompany.com)

California: ⚠️WARNING: Cancer and Reproductive Harm - [www.P65Warnings.ca.gov](http://www.P65Warnings.ca.gov)

