



BD Transmission Cooler











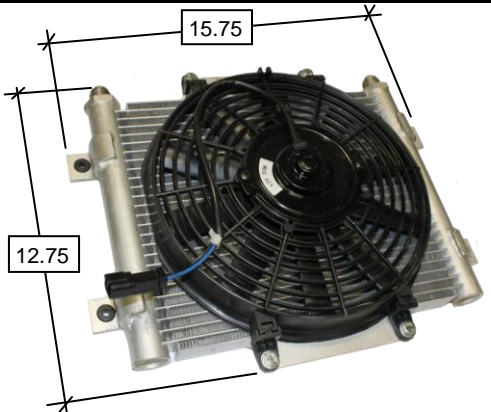



**Dodge (68RFE, 518, 47RH, 47RE & 48RE)
Ford (All) & Chevy (Allison) Transmissions**



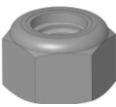

P/N#	1030606-5/16
P/N#	1030606-3/8
P/N#	1030606-1/2
P/N#	1030606-5/8

PLEASE READ ALL INSTRUCTIONS BEFORE INSTALLATION







KIT CONTENTS:

Please check to make sure that you have all the parts listed in this kit **before** you start the disassembly of your truck.

Transmission Cooler Base Kit - 1030605					
1300601		1300602		1300603	
					
<i>Cooler</i>		<i>L Brackets</i>		<i>Wiring Harness</i>	
Qty: 1		Qty: 6		Qty: 1	
1100110	1100111	1230116	1604104	1110031	1130227
					
<i>1/4 x 3/4" Bolts</i>	<i>1/4 Washers</i>	<i>1/4 Nyloc Nuts</i>	<i>5/16" x 1" Long Bolts</i>	<i>5/16 Flat Washers</i>	<i>5/16 Nyloc Nuts</i>
Qty: 4	Qty: 8	Qty: 4	Qty: 6	Qty: 12	Qty: 6
1300130	1300131	1300132	1400113	1452821	1300604
					
<i>Tie Wrap (Long)</i>	<i>Tie Wrap (Medium)</i>	<i>Tie Wrap (Small)</i>	<i>Insulated Clamp</i>	<i>Gear Clamp</i>	<i>Self-Threading Bolt</i>
Qty: 5	Qty: 5	Qty: 5	Qty: 1	Qty: 4	Qty: 4

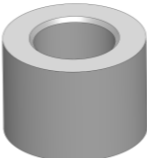
1400134	1300605	1400133	1400135
			
<i>-10/-10 Jic Sweep Bend Fitting</i>	<i>Temp Sensor</i>	<i>-10/1/2" Barb Sensor Adapter</i>	<i>-10 Jic/ 1/2" Hose 90 Deg Fitting</i>
Qty: 1	Qty: 1	Qty: 1	Qty: 1

5/16" Fitting Kit – 1030606-5/16		
1400128	1400107	1604054
		
<i>1/4" NPT / 5/16 Comp</i>	<i>1/4" NPT / 1/2" Barb</i>	<i>1/2" ID Hose</i>
Qty: 2	Qty: 2	Qty: 183"

3/8" Fitting Kit – 1030606-3/8			
1400105	1400121	1604054	
			
<i>3/8" NPT / 1/2" Barb</i>	<i>3/8" NPT / 3/8" Comp</i>	<i>1/2" ID Hose</i>	
Qty: 2	Qty: 2	Qty: 183"	
1600034	1600035	1604044	1604045
			
Bypass Tube Eliminator (Front)	Bypass Tube Eliminator (Rear)	Washer	Washer
Qty: 1	Qty: 1	Qty: 2	Qty: 2

Bypass Tube Eliminators are only required on 4R100 Transmissions

1/2" Fitting Kit – 1030606-1/2			
1400132	1400138	1400136	1604054
			
1/2" Comp / 1/2" Barb	1/2" Sleeve	1/2" Nut	1/2" ID Hose
Qty: 2	Qty: 2	Qty: 2	Qty: 183"

5/8" Fitting Kit – 1030606-5/8			
1400131	1400139	1400137	1604054
			
5/8" Comp / 1/2" Barb	5/8" Sleeve	5/8" Nut	1/2" ID Hose
Qty: 2	Qty: 2	Qty: 2	Qty: 183"

Vehicle Applications			
Year	Make	Application	Fitting Tube size
1991-1999	Chevy	4L80	5/16" Tube
1999-2000	Chevy	4L80	3/8" Tube
1993-2012	Dodge (All)	518,47RH, 47RE, 48RE, 68RFE	1/2" Tube
1994-1997	Ford	E40D	5/16" Tube
1999-2002	Ford	4R100	3/8" Tube
2003-2010	Ford	5R110	1/2" Tube
2001-2010	GM/Duramax	Allison 1000	5/8" Tube

Before you install your BD Transmission Cooler

- ◆ **If using the BD transmission cooler in extreme temperatures a bypass valve is recommended.**
- ◆ **Cooler fan is rated for 66% duty cycle Maximum. Exceeding the duty cycle may result in voiding the warranty.**
- ◆ **The temperature sensor is designed to turn on at 180°F / off at 165°F.**

Installation

***Important* Cooler fan is rated for 66% duty cycle Maximum. Exceeding the duty cycle may result in voiding the warranty.**

Note: The temperature sensor is designed to turn on at 180°F / off at 165°F.

1) Block wheels of vehicle for safety and disconnect negative battery terminals (record radio settings before disconnecting the batteries).

2) Using a hoist lift vehicle to access transmission area.

3) Locate suitable location to mount transmission cooler. Choose a location where there will be adequate airflow through the cooler. If the cooler is mounted against a surface ensure there is at least 1" of clearance behind the cooler and that it is away from heat sources, rotating parts and debris.(fig.2)

4) Assemble L brackets and 5/16" hardware to mount the transmission cooler to the frame rail. Trim bracket pieces where necessary, deburr sharp edges and paint areas that are exposed to prevent corrosion.

Note: This is a universal cooler that can be mounted in a variety of locations

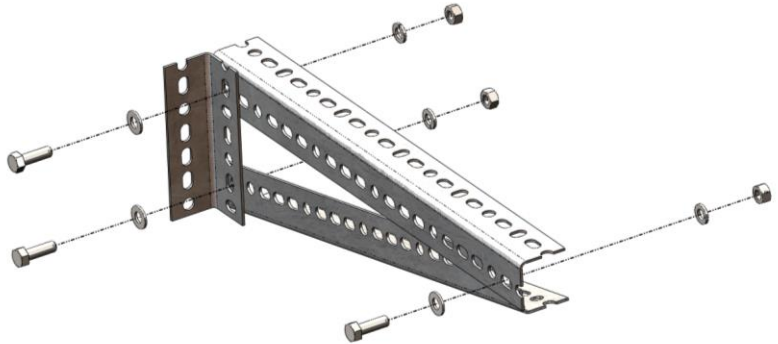

1	1300602– L Bracket
2	1604104 – 5/16" X 1" Bolt
3	1110031 – 5/16" Flat washer
4	1110032 – 5/16" Lock washer
5	1130227 – 5/16" Nyloc nut

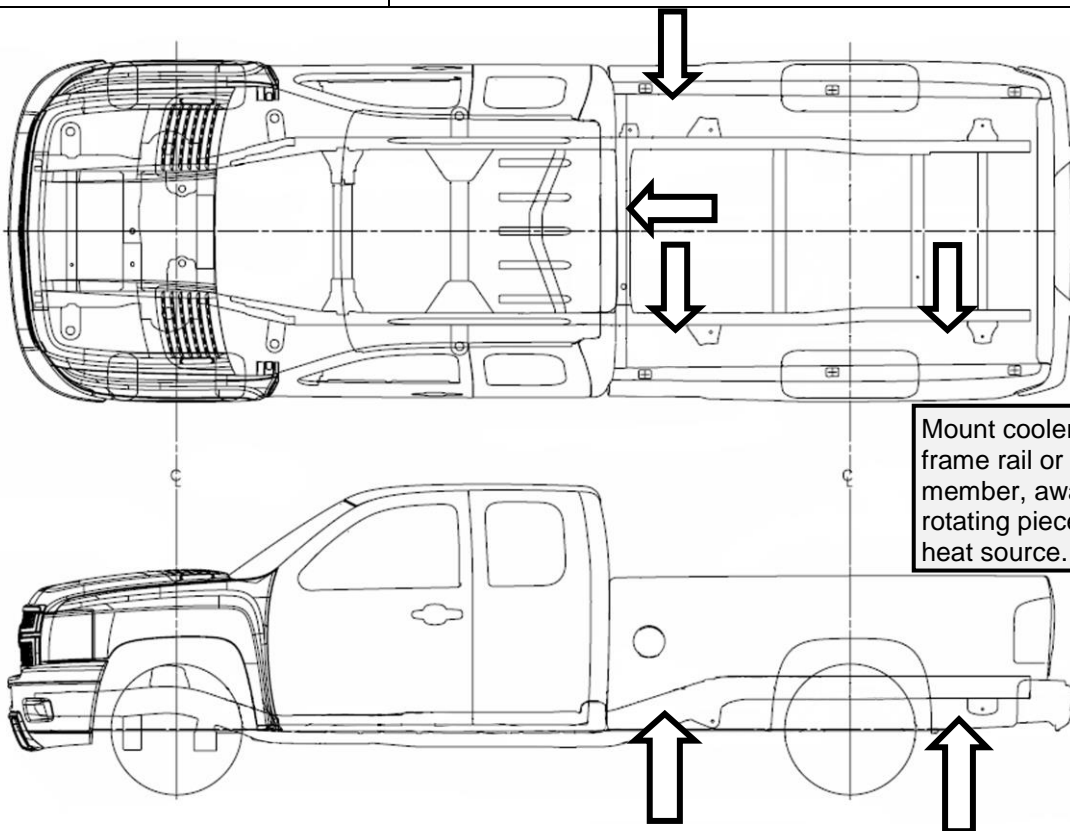
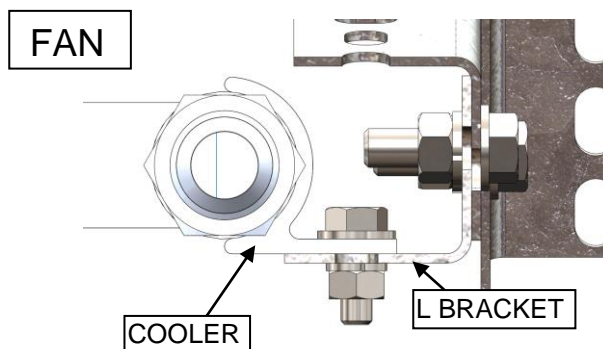

Fig.2

- 5) Mount transmission cooler to bracket (fan side up) with 1/4" supplied hardware.



- 6) Mark and drill four 19/64" holes into frame for self-threading bolts to mount cooler assembly.

- 7) Mount cooler assembly to frame rail using supplied self-threading bolts and secure with supplied nuts and washers.

- 8) Apply small amount of pipe sealant to temp switch thread and thread into JIC adaptor until snug.

- 9) Thread JIC 90deg fittings onto cooler hand tight. Large sweep tube fitting connects to outlet.

- 10) Thread JIC temp switch adaptor onto cooler large sweep connector.

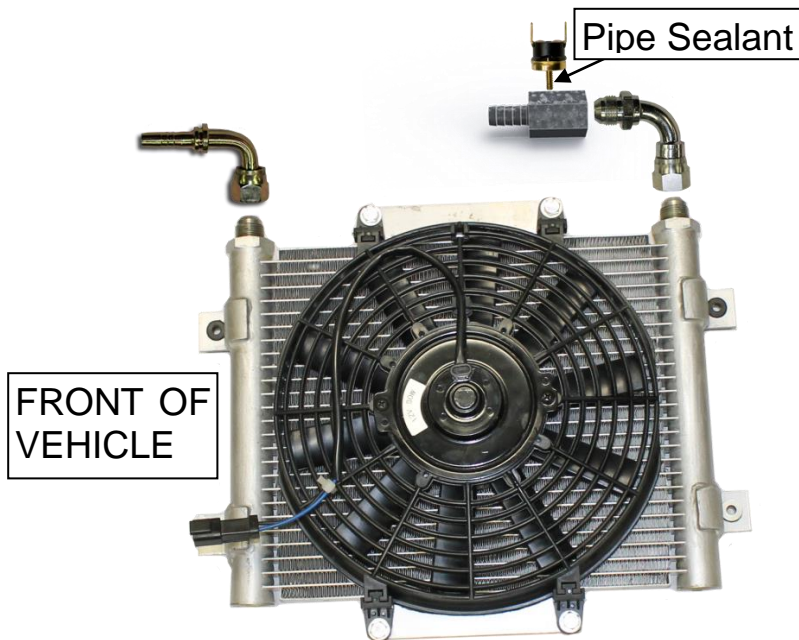
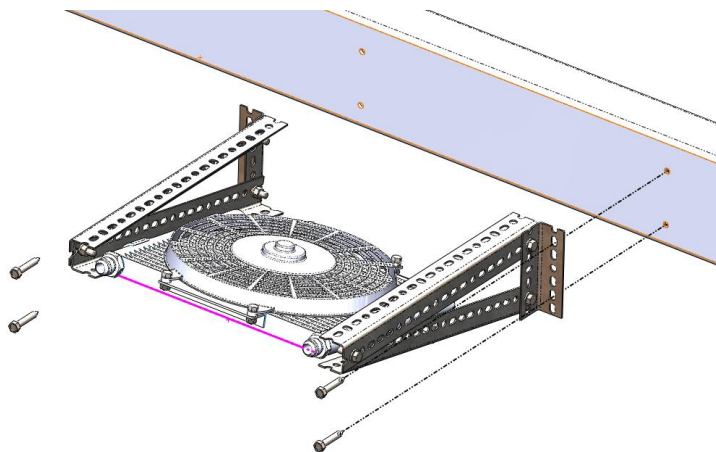

- 11) Locate transmission inlet line (fig 1.1). Mark and cut transmission line where the line is completely straight with no bends or damage for about 3" to mount compression fittings. NOTE: Tube attached to transmission can be rotated for easy routing of hose.
- 12) Cut transmission line with pipe cutter. Deburr inner and outer pipe edges on both sides.
- 13) Insert barb-compression fitting onto cut cooler line ensuring fitting bottoms out and tighten hand tight. Then using two wrenches tighten to crush ferrule 1 1/4 turns.
- 14) Measure/cut supplied 1/2" hose to length ensuring hose reaches cooler from transmission without being stressed.
- 15) Install hoses onto barbed fittings using provided gear clamps and tighten. (Refer to general hose routing diagram for general layout.)
- 16) Tighten all fittings ensuring a positive connection.
- 17) Secure hoses with provided tie straps and insulated clamp.

Line Position Reference (fig 1.1)

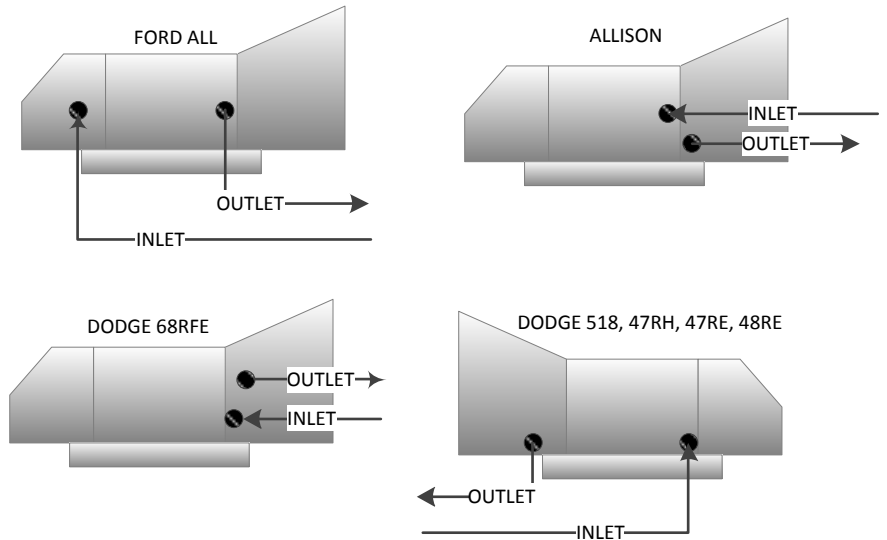

General hose routing (Dodge 518, 47RH, 47RE, 48RE)

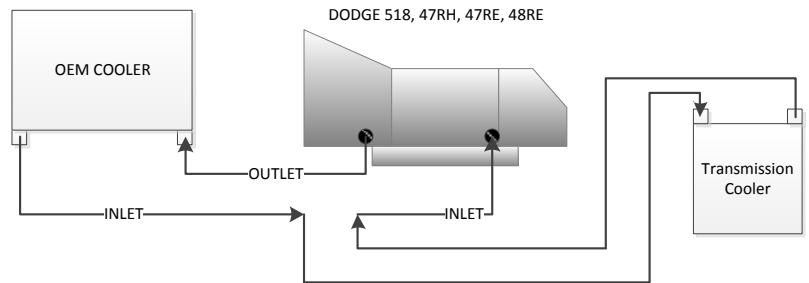

Using the Compression Fitting

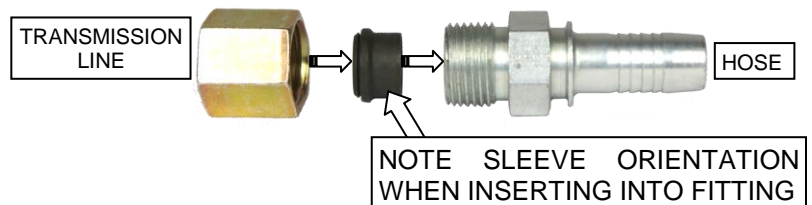

- 18) Route wiring harness from transmission cooler along frame into engine compartment.
- 19) Under vehicle insert two pin connector on harness into fan motor connector, then connect harness to temperature switch with blade connectors once appropriate wire is cut and trimmed to length.
- 20) Mount relay in a suitable location in the engine compartment using supplied self-taping screw.
- 21) Next trim the wires to length and crimp the ring terminals to the BLACK and RED wires. Connect positive terminal only. (Driver side battery)
- 22) Lastly open the fuse box and locate the 12V ignition switched fuse by using a digital volt meter or 12V test light. Remove fuse and install fuse tapper onto fused side and reinstall. (5 amp fuse is minimum requirement)
- 23) Cut yellow wire on wiring harness to appropriate length, strip end and crimp on supplied flag connector. Install flag connector onto fuse tapper. Close fuse box carefully not to damage wire. (trim fuse box if necessary)
- 24) Secure wiring harness to vehicle using supplied tie straps.

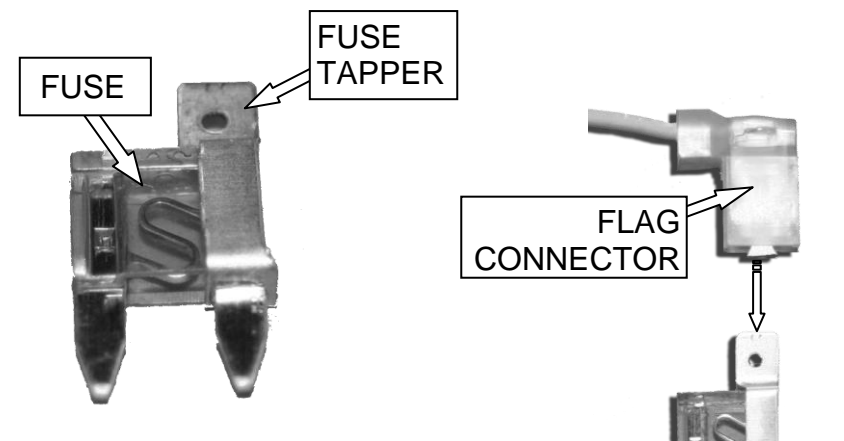
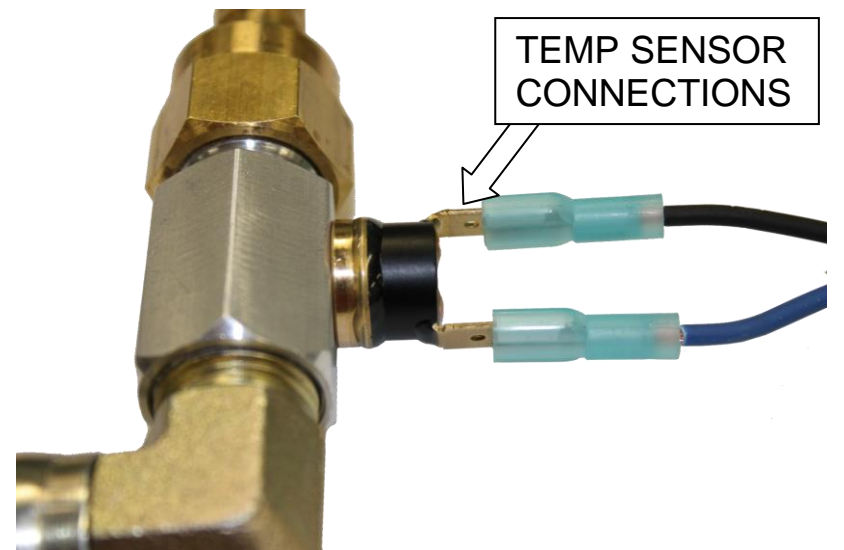
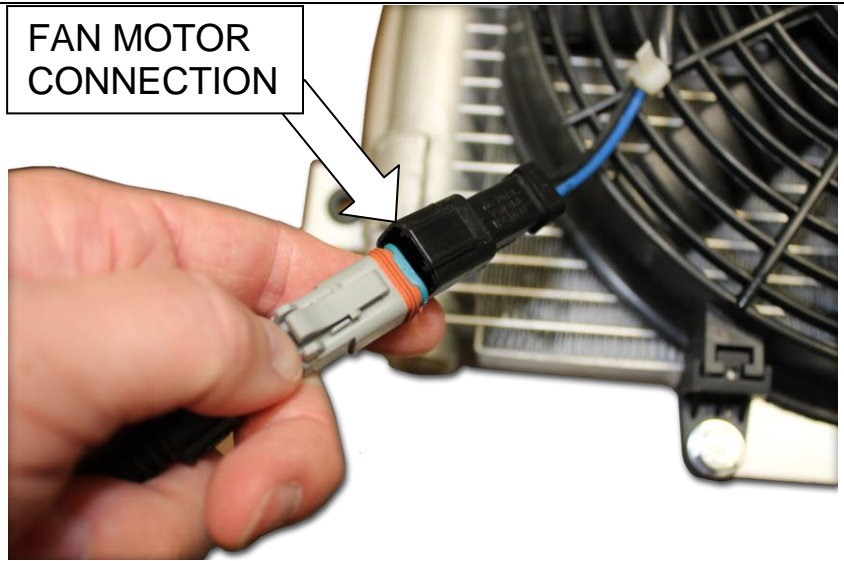

25) Reconnect negative battery terminal with black ring terminal from harness.

26) Start engine, shift through gears manually and check fluid level. Top up fluid with appropriate fluid type. (Refer to table below)

Application	Oil Type
Ford E40D & 4r100	Mercon V
Ford Torqshift 5r110	Mercon SP
All Dodge's (518, 47xx, 48re, 68rfe)	Mopar ATF +4
GM Allison	Dexron VI or Transynd

27) Remove wheel blocks and road test vehicle. Recheck fluid level once vehicle reaches operating temperature.

If you have any technical difficulties, concerns, comments, or complaints, please phone our Technical Support hotline at (800) 887-5030 between 8:30am-5:00pm PST (Pacific Standard Time) Monday to Friday, or post a message on the BD Discussion Forums located at:

<http://forum.bd-power.com/>



Visit our Internet forums at <http://www.dieselperformance.com> and share your comments or technical support questions with some of the industry's leading experts in the diesel field.

BD Engine Brake Inc.

Plant Address: 33541 MacLure Rd. Abbotsford, BC, Canada V2S 7W2

U.S. Shipping Address: 88-446 Harrison St, Sumas, WA 98295 U.S. Mailing Address: P.O. Box 231, Sumas, WA 98295

Phone: 604-853-6096 | Fax: 604-853-8749 | Internet: www.bd-power.com