



# **SUPERLIFT®**

## S U S P E N S I O N

### **2017 FORD F250 / F350 4”** (STANDARD, RADIUS ARM, AND 4-LINK; COIL SPRING AND COILOVER) **INSTALLATION INSTRUCTIONS**

**THANK YOU FOR CHOOSING SUPERLIFT FOR ALL YOUR SUSPENSION NEEDS!!**

#### **INTRODUCTION**

Installation requires a professional mechanic.

Prior to beginning, inspect the vehicles steering, driveline, and brake systems, paying close attention to the suspension link arms and bushings, sway bars and bushings, tie rod ends, pitman arm, ball joints and wheel bearings. Also check the steering sector-to-frame and all suspension-to-frame attaching points for stress cracks. The overall vehicle must be in excellent working condition; repair or replace all worn parts.

**Read instructions several times before starting. Be sure you have all needed parts and know where they install. Read each step completely as you go.**

#### **NOTES:**

- Prior to beginning the installation, check all parts and hardware in the box with the parts list below. If you find a packaging error, contact Superlift® directly. Do not contact the dealer where the system was originally purchased. You will need the control number from each box when calling; this number is located at the bottom of the part number label and to the right of the bar code.
- Front end alignment is necessary.
- A foot-pound torque reading is given in parenthesis ( ) after each appropriate fastener.
- Tool and Wrench/Socket size is given in brackets { } after each appropriate step.
- Prior to attaching components, be sure all mating surfaces are free of grit, grease, excessive undercoating, etc.
- A factory service manual should be on hand for reference.
- Use the check-off box “” found at each step to help you keep your place. Two “” denotes that one check-off box is for the driver side and one is for the passenger side. Unless otherwise noted, always start with the driver side.

# STANDARD KIT (RADIUS ARM DROP)

K KIT BREAKDOWN					
Kit Part Number K164			Kit Part Number K164B		
Part Number	Qty.	Part Description	Part Number	Qty.	Part Description
294	1	front coil springs	294	1	front coil springs
9092	1	radius arm drops	9092	1	radius arm drops
9093	1	track bar drop and stabilizer bracket	9093	1	track bar drop and stabilizer bracket
9095	1	front and rear shock absorbers, Superide	9095B	1	front and rear shock absorbers, Bilstein
9099	1	bump stops and rear brake line brackets	9099	1	bump stops and rear brake line brackets
9091	1	rear block kit	9091	1	rear block kit

KIT BREAKDOWN					
Kit Part Number 294			Kit Part Number 9095		
Part Number	Qty.	Part Description	Part Number	Qty.	Part Description
01-294	2	front coil springs, diesel	01-88510	2	shock cylinder, front Superide
Kit Part Number 9092			01-85160	2	shock cylinder, rear Superide
Kit Part Number 9092			77-9095	1	hardware bag
Kit Part Number 9092			OR		
Kit Part Number 9092			Kit Part Number 9095B		
55-05-9090	2	radius arm drop	Kit Part Number 9095B		
77-9092	1	hardware bag, radius arm drop	Part Number	Qty.	Part Description
Kit Part Number 9093			BE5-6681-H5	2	shock cylinder, front Bilstein
Kit Part Number 9093			BE5-6250-H5	2	shock cylinder, rear Bilstein
Kit Part Number 9093			77-80032	1	hardware bag
55-21-9090	1	stabilizer bracket	Kit Part Number 9091		
55-01-9062	1	track bar bracket	Part Number	Qty.	Part Description
77-9093	1	hardware bag, track bar keys	55-02-200	2	rear block, 5"
77-9093-1	1	hardware bag, front brake line bracket	55-03-200	2	rear block shim
Kit Part Number 9099			77-1509	1	9/16" ubolt nuts and washers
Kit Part Number 9099			77-1507	1	7/16" ubolts, nuts, and washers
55-15-9090	2	bump stop bracket, front	11962	4	9/16" x 3-1/4" x 15" ubolt, large radius
55-09-9074	1	brake line bracket, rear			
77-9099	1	hardware bag			

HARDWARE BAG BREAKDOWN					
Kit Part Number 77-9092			Kit Part Number 77-9095		
Part Number	Qty.	Part Description	Part Number	Qty.	Part Description
18mx2.5x130cs	4	18mm x 130mm bolt, 2.5 pitch	142731	2	shock stem hardware bag
18mfw	8	18mm flat washer	01-60416	2	5/8" ID bushing
18mnn	4	18mm nyloc nut, 2.5 pitch	01-60418	2	3/4" ID bushing
Kit Part Number 77-9093			19-5040	2	sleeve, 0.75" OD x 0.565" ID x 1.48" Long
Kit Part Number 77-9093			Kit Part Number 77-9099		
55-05-9024	2	track bar keys	Part Number	Qty.	Part Description
Kit Part Number 77-9093-1			8mx1.25x75cs	2	8mm x 75mm bolt, 1.25 pitch
Kit Part Number 77-9093-1			716x1c5cs	1	7/16" x 1" bolt, coarse thread
Kit Part Number 77-9093-1			716sw	2	7/16" sae washer
55-22-9090	2	brake line bracket, front	716c5nn	1	7/16" nyloc nut, coarse thread
38x1c5cs	2	3/8" x 1" bolt, coarse thread	Kit Part Number 77-1509		
38sw	2	3/8" sae washer	Part Number	Qty.	Part Description
38c5nn	2	3/8" nyloc nut, coarse thread	1511-B09	8	9/16" ubolt nut
14x12stb	1	1/4" x 1/2" bolt, self tapping	916cw	8	9/16" ubolt washer
716x212c5cs	1	7/16" x 2-1/2" bolt, coarse thread	Kit Part Number 77-1507		
716sw	1	7/16" sae washer	Part Number	Qty.	Part Description
716c5nn	1	7/16" nyloc nut, coarse thread	716x314x412ub	4	7/16" x 3-1/4" x 4-1/2" ubolt, square
f470l	1	thread locking compound	716f8sfn	8	7/16" flange nut, fine thread

# STANDARD KIT (RADIUS ARM DROP)

Step	Part Number	Qty. per Kit	Description	New Attaching Hardware	Qty. per Bracket	Hardware Bag Number
13	55-01-9062	1	track bar bracket	55-05-9024 - track bar keys	2	77-9093
15	55-05-9090	2	radius arm drop	18mm x 2.5 x 130mm bolt, 2.5 pitch	2	77-9092
				18mm flat washer	4	
				18mm nyloc nut, 2.5 pitch	2	
				sleeve, 1.125" OD x 0.188 wall x 2.736 long	1	
17	01-294	2	coil springs, diesel			
18	01-88510	2	shock cylinder, front Superide	142731 - shock stem hardware bag	1	77-9095
	or					
	BE5-6681-H5	2	shock cylinder, front Bilstein			
19	55-22-9090	2	brake line bracket, front	3/8" x 1" bolt, coarse thread	2	77-9093-1
				3/8" sae washer	2	
				3/8" nyloc nut, coarse thread	2	
				1/4" x 1/2" bolt, self tapping	1	
24	55-15-9090	2	bump stop bracket, front	8mm x 75mm bolt, 1.25 pitch	1	77-9099
28	55-21-9090	1	stabilizer bracket	7/16" x 2-1/2" bolt, coarse thread	1	77-9093-1
				7/16" sae washer	1	
				7/16" nyloc nut	1	
34	55-02-200	2	rear block, 5"	11962 - 9/16" x 3-1/4" x 15" ubolt, large radius	2	
				55-03-200 - block shim plate	2	
				7/16" x 3-1/4" x 4-1/2" ubolt, square	2	77-1507
				7/16" flange nut, fine thread	4	
				9/16" ubolt nut	4	77-1509
				9/16" ubolt washer	4	
35	01-85160	2	shock cylinder, rear Superide	01-60416 - 5/8" ID bushing	1	77-9095
	or			01-60418 - 3/4" ID bushing	1	
	BE5-6250-H5	2	shock cylinder, rear Bilstein	19-5040 - sleeve, 0.75" OD x 0.565" ID x 1.48" Long	2	
36	55-09-9074	1	brake line bracket, rear	7/16" x 1" bolt, coarse thread	1	77-9099
				7/16" sae washer	2	
				7/16" nyloc nut, coarse thread	1	

# RADIUS ARM KIT

K KIT BREAKDOWN					
Kit Part Number K165			Kit Part Number K165B		
Part Number	Qty.	Part Description	Part Number	Qty.	Part Description
294	1	front coil springs	294	1	front coil springs
9095	1	front and rear shock absorbers, Superide	9095B	1	front and rear shock absorbers, Bilstein
9093	1	track bar drop and stabilizer bracket	9093	1	track bar drop and stabilizer bracket
9500	1	radius arms	9500	1	radius arms
9099	1	bump stops and rear brake line brackets	9099	1	bump stops and rear brake line brackets
9091	1	rear block kit	9091	1	rear block kit
Kit Part Number K165KG					
Part Number	Qty.	Part Description			
SLS146-01	1	coilover shocks, King			
SLS171-01	1	rear shock absorbers, King			
9093	1	track bar drop and stabilizer bracket			
9500	1	radius arms			
9099	1	bump stops and rear brake line brackets			
9091	1	rear block kit			

KIT BREAKDOWN					
Kit Part Number 294			Kit Part Number 9091		
Part Number	Qty.	Part Description	Part Number	Qty.	Part Description
01-294	2	front coil springs, diesel	55-02-200	2	rear block, 5"
			55-03-200	2	rear block shim
Kit Part Number 9093			77-1509	1	9/16" ubolt nuts and washers
			77-1507	1	7/16" ubolts, nuts, and washers
Part Number	Qty.	Part Description	11962	4	9/16" x 3-1/4" x 15" ubolt, large radius
55-21-9090	1	stabilizer bracket			
55-01-9062	1	track bar bracket	Kit Part Number 9095		
77-9093	1	hardware bag, track bar keys	01-88510	2	shock cylinder, front Superide
77-9093-1	1	hardware bag, front brake line bracket	01-85160	2	shock cylinder, rear Superide
Kit Part Number 9500			77-9095	1	hardware bag
Part Number	Qty.	Part Description	OR		
66-09-9000	1	radius arm, driver side	Kit Part Number 9095B		
66-10-9000	1	radius arm, passenger side	BE5-6681-H5	2	shock cylinder, front Bilstein
77-9500	1	hardware bag, cam bolts	BE5-6250-H5	2	shock cylinder, rear Bilstein
Kit Part Number 9099			77-80032	1	hardware bag
Part Number	Qty.	Part Description			
55-15-9090	2	bump stop bracket, front			
55-09-9074	1	brake line bracket, rear			
77-9099	1	hardware bag			

HARDWARE BAG BREAKDOWN					
Kit Part Number 77-9093			Kit Part Number 77-9095		
Part Number	Qty.	Part Description	Part Number	Qty.	Part Description
55-05-9024	2	track bar keys	142731	2	shock stem hardware bag
			01-60416	2	5/8" ID bushing
Kit Part Number 77-9093-1			01-60418	2	3/4" ID bushing
			19-5040	2	sleeve, 0.75" OD x 0.565" ID x 1.48" Long
Part Number	Qty.	Part Description	Kit Part Number 77-9099		
55-22-9090	2	brake line bracket, front	8mx1.25x75cs	2	8mm x 75mm bolt, 1.25 pitch
38x1c5cs	2	3/8" x 1" bolt, coarse thread	716x1c5cs	1	7/16" x 1" bolt, coarse thread
38sw	2	3/8" sae washer	716sw	2	7/16" sae washer
38c5nn	2	3/8" nyloc nut, coarse thread	716c5nn	1	7/16" nyloc nut, coarse thread
14x12stb	1	1/4" x 1/2" bolt, self tapping			
716x212c5cs	1	7/16" x 2-1/2" bolt, coarse thread	Kit Part Number 77-1509		
716sw	1	7/16" sae washer	1511-B09	8	9/16" ubolt nut
716c5nn	1	7/16" nyloc nut, coarse thread	916cw	8	9/16" ubolt washer
f470l	1	thread locking compound	Kit Part Number 77-1507		
Kit Part Number 77-9500			716f8sfm	8	7/16" flange nut, fine thread
Part Number	Qty.	Part Description			
18mx2.5x140cs	2	18mm x 140mm bolt, 2.5 pitch			
18mfw	5	18mm flat washer			
18mln	4	18mm stover nut	Kit Part Number 77-1507		
55-11-9000	2	cam bolt	716x314x412ub	4	7/16" x 3-1/4" x 4-1/2" ubolt, square
55-21-9910	4	cam washer	716f8sfm	8	7/16" flange nut, fine thread
1112ct	4	zip tie			

# RADIUS ARM KIT

Step	Part Number	Qty. per Kit	Description	New Attaching Hardware	Qty. per Bracket	Hardware Bag Number
13	55-01-9062	1	track bar bracket	55-05-9024 - track bar keys	2	77-9093
15	66-09-9000	1	radius arm, driver side	18mm x 2.5 x 130mm bolt, 2.5 pitch	1	77-9500
				18mm flat washer	2	
				18mm nyloc nut, 2.5 pitch	2	
				55-11-9000 - cam bolt	1	
				55-21-9910 - cam washer	2	
15	66-10-9000	1	radius arm, passenger side	18mm x 2.5 x 130mm bolt, 2.5 pitch	1	77-9500
				18mm flat washer	2	
				18mm nyloc nut, 2.5 pitch	2	
				55-11-9000 - cam bolt	1	
				55-21-9910 - cam washer	2	
17	01-294	2	coil springs, diesel			
	or					
	SL5146-01	2	coilover shock, King			
18	01-88510	2	shock cylinder, front Superide	142731 - shock stem hardware bag	1	77-9095
	or					
	BE5-6681-H5	2	shock cylinder, front Bilstein			
20	55-22-9090	2	brake line bracket, front	3/8" x 1" bolt, coarse thread	2	77-9093-1
				3/8" sae washer	2	
				3/8" nyloc nut, coarse thread	2	
				1/4" x 1/2" bolt, self tapping	1	
24	55-15-9090	2	bump stop bracket, front	8mm x 75mm bolt, 1.25 pitch	1	77-9099
28	55-21-9090	1	stabilizer bracket	7/16" x 2-1/2" bolt, coarse thread	1	77-9093-1
				7/16" sae washer	1	
				7/16" nyloc nut	1	
34	55-02-200	2	rear block, 5"	11962 - 9/16" x 3-1/4" x 15" ubolt, large radius	2	77-1507
				55-03-200 - block shim plate	2	
				7/16" x 3-1/4" x 4-1/2" ubolt, square	2	77-1509
				7/16" flange nut, fine thread	4	
				9/16" ubolt nut	4	77-1509
				9/16" ubolt washer	4	
35	01-85160	2	shock cylinder, rear Superide	01-60416 - 5/8" ID bushing	1	77-9095
	or			01-60418 - 3/4" ID bushing	1	
	BE5-6250-H5	2	shock cylinder, rear Bilstein	19-5040 - sleeve, 0.75" OD x 0.565" ID x 1.48" Long	2	
	or					
	SL5171-01	2	shock cylinder, rear King			
36	55-09-9074	1	brake line bracket, rear	7/16" x 1" bolt, coarse thread	1	77-9099
				7/16" sae washer	2	
				7/16" nyloc nut, coarse thread	1	

# 4-LINK KIT

K KIT BREAKDOWN					
Kit Part Number K166			Kit Part Number K166B		
Part Number	Qty.	Part Description	Part Number	Qty.	Part Description
294	1	front coil springs	294	1	front coil springs
9104	1	radius arm drops	9104	1	radius arm drops
9093	1	track bar drop and stabilizer bracket	9093	1	track bar drop and stabilizer bracket
9095	1	front and rear shock absorbers	9095B	1	front and rear shock absorbers
9099	1	bump stops and rear brake line brackets	9099	1	bump stops and rear brake line brackets
9091	1	rear block kit	9091	1	rear block kit
9096	1	lower 4-links	9096	1	lower 4-links
9098	1	upper 4-links	9098	1	upper 4-links
Kit Part Number K166KG					
Part Number	Qty.	Part Description			
SL5146-01	1	front coilovers			
SL5171-01	1	rear shock absorbers			
9104	1	radius arm drops			
9093	1	track bar drop and stabilizer bracket			
9099	1	bump stops and rear brake line brackets			
9091	1	rear block kit			
9096	1	lower 4-links			
9098	1	upper 4-links			

KIT BREAKDOWN					
Kit Part Number 294			Kit Part Number 9095		
Part Number	Qty.	Part Description	Part Number	Qty.	Part Description
01-294	2	front coil springs, diesel	01-88510	2	shock cylinder, front Superide
			01-85160	2	shock cylinder, rear Superide
Kit Part Number 9104			77-9095		
			OR		
Part Number	Qty.	Part Description	Kit Part Number 9095B		
55-25-9090	2	radius arm drops, 4 link			
77-9104	1	hardware bag			
Kit Part Number 9093			Part Number Qty. Part Description		
55-02-9090	1	stabilizer bracket	BE5-6681-H5	2	shock cylinder, front Bilstein
55-01-9062	1	track bar bracket	BE5-6250-H5	2	shock cylinder, rear Bilstein
77-9093	1	hardware bag, track bar keys	77-80032	1	hardware bag
77-9093-1	1	hardware bag, front brake line bracket	Kit Part Number 9096		
Kit Part Number 9091			Part Number	Qty.	Part Description
55-02-200	2	rear block, 5"	55-08-9090	2	link arm, lower
55-03-200	2	rear block shim	77-9500	1	hardware bag, cam bolts
77-1509	1	9/16" ubolt nuts and washers	Kit Part Number 9098		
77-1507	1	7/16" ubolts, nuts, and washers	55-07-9090	2	link arm, upper
11962	4	9/16" x 3-1/4" x 15" ubolt, large radius	Kit Part Number 9099		
			55-15-9090	2	bump stop bracket, front
			55-09-9074	1	brake line bracket, rear
			77-9099	1	hardware bag

HARDWARE BAG BREAKDOWN					
Kit Part Number 77-9093			Kit Part Number 77-9099		
Part Number	Qty.	Part Description	Part Number	Qty.	Part Description
55-05-9024	2	track bar keys	8mx1.25x75cs	2	8mm x 75mm bolt, 1.25 pitch
Kit Part Number 77-9093-1			716x1c5cs	1	7/16" x 1" bolt, coarse thread
55-22-9090	2	brake line bracket, front	716sw	2	7/16" sae washer
38x1c5cs	2	3/8" x 1" bolt, coarse thread	716c5nn	1	7/16" nyloc nut, coarse thread
38sw	2	3/8" sae washer	Kit Part Number 77-1509		
38c5nn	2	3/8" nyloc nut, coarse thread	1511-809	8	9/16" ubolt nut
14x12stb	1	1/4" x 1/2" bolt, self tapping	916cw	8	9/16" ubolt washer
716x212c5cs	1	7/16" x 2-1/2" bolt, coarse thread	Kit Part Number 77-1507		
716sw	1	7/16" sae washer	Part Number Qty. Part Description		
716c5nn	1	7/16" nyloc nut, coarse thread	716x314x412ub	4	7/16" x 3-1/4" x 4-1/2" ubolt, square
f470l	1	thread locking compound	716f8sfm	8	7/16" flange nut, fine thread
Kit Part Number 77-9500			Kit Part Number 77-9104		
Part Number Qty. Part Description			Part Number Qty. Part Description		
18mx2.5x140cs	2	18mm x 140mm bolt, 2.5 pitch	18mx2.5x120cs	2	18mm x 120mm bolt, 2.5 pitch
18mfw	5	18mm flat washer	18mn	2	18mm stover nut
18mn	4	18mm stover nut	Kit Part Number 77-9095		
55-11-9000	2	cam bolt	Part Number Qty. Part Description		
55-21-9910	4	cam washer	142731	2	shock stem hardware bag
1112ct	4	zip tie	01-60416	2	5/8" ID bushing
			01-60418	2	3/4" ID bushing
			19-5040	2	sleeve, 0.75" OD x 0.565" ID x 1.48" Long

# 4-LINK KIT

Step	Part Number	Qty. per Kit	Description	New Attaching Hardware	Qty. per Bracket	Hardware Bag Number
13	55-01-9062	1	track bar bracket	55-05-9024 - track bar keys	2	77-9093
15	55-25-9090	2	radius arm, 4 link	18mm x 2.5 x 130mm bolt, 2.5 pitch	1	77-9500
				18mm flat washer	2	
				18mm nyloc nut, 2.5 pitch	3	
				18mm x 2.5 x 120mm bolt, 2.5 pitch	1	77-9104
16	55-08-9090	2	link arm, lower	55-11-9000 - cam bolt	1	77-9500
				55-21-9910 - cam washer	2	
16	55-07-9090	2	link arm, upper			
17	01-294	2	coil springs, diesel			
	or					
	SL5146-01	2	coilover shock, King			
18	01-88510	2	shock cylinder, front Superide	142731 - shock stem hardware bag	1	77-9095
	or					
	BE5-6681-H5	2	shock cylinder, front Bilstein			
20	55-22-9090	2	brake line bracket, front	3/8" x 1" bolt, coarse thread	2	77-9093-1
				3/8" sae washer	2	
				3/8" nyloc nut, coarse thread	2	
				1/4" x 1/2" bolt, self tapping	1	
24	55-15-9090	2	bump stop bracket, front	8mm x 75mm bolt, 1.25 pitch	1	77-9099
28	55-21-9090	1	stabilizer bracket	7/16" x 2-1/2" bolt, coarse thread	1	77-9093-1
				7/16" sae washer	1	
				7/16" nyloc nut	1	
34	55-02-200	2	rear block, 5"	11962 - 9/16" x 3-1/4" x 15" ubolt, large radius	2	
				55-03-200 - block shim plate	2	
				7/16" x 3-1/4" x 4-1/2" ubolt, square	2	77-1507
				7/16" flange nut, fine thread	4	
				9/16" ubolt nut	4	77-1509
				9/16" ubolt washer	4	
35	01-85160	2	shock cylinder, rear Superide	01-60416 - 5/8" ID bushing	1	77-9095
	or			01-60418 - 3/4" ID bushing	1	
	BE5-6250-H5	2	shock cylinder, rear Bilstein	19-5040 - sleeve, 0.75" OD x 0.565" ID x 1.48" Long	2	
	or					
	SL5171-01	2	shock cylinder, rear King			
36	55-09-9074	1	brake line bracket, rear	7/16" x 1" bolt, coarse thread	1	77-9099
				7/16" sae washer	2	
				7/16" nyloc nut, coarse thread	1	

## **FRONT DISASSEMBLY**

**NOTE:** Save all factory components and hardware for reuse, unless noted.

### **1) PREPARE VEHICLE...**

Chock rear tires and place transmission in neutral. Raise front of vehicle with a jack and secure a jack stand beneath each frame rail, behind the radius arm mounts. Ease the frame down onto the stands and place transmission in park. Remove front tires. {Lug Nuts 21mm}

### **2) TRACK BAR...**

[Illustration 1] Prior to raising the vehicle, disconnect the track bar from its attachment point on the frame and let the bar hang. {30mm}

**Illustration 1**



**Illustration 2**

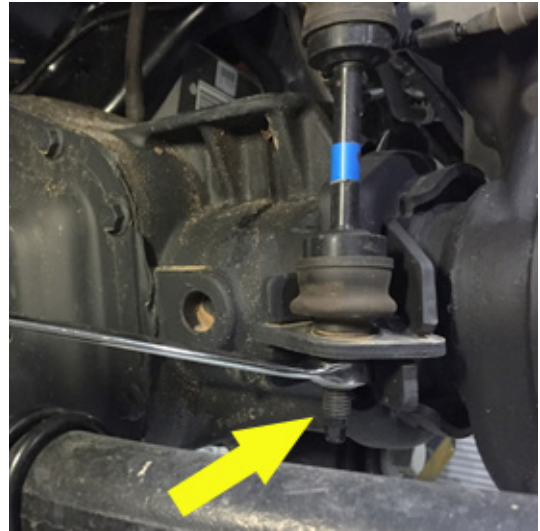

### **3) SWAY BAR LINKS...**

[Illustration 2] Disconnect the sway bar links for their attachment points on the sway bar. {18mm}

**Perform steps 4 through 9 one side at a time.**

### **4) STEERING STABILIZER...**

Disconnect the steering stabilizer from the frame bracket. {15mm}

[Illustration 3] Remove the factory steering stabilizer bracket from the frame. {13mm}

### **5) DRAG LINK...**

[Illustration 4] Remove the cotter pin and castle nut from the drag link, then using the appropriate puller tool, disconnect the drag link from the pitman arm. {pliers, 24mm}

### **6) BRAKE LINE BRACKETS...**

[Illustration 5] Remove the bolt holding the brake line bracket to the axle. {10mm}

**Illustration 3**





□□ [Illustration 6] Remove the bolt retaining the brake line bracket to the frame. {13mm}

**7) DIFFERENTIAL VENT HOSE...**

□ Disconnect the vent hose from the axle. {plastic fastener removal tool}

**8) AXLE VACUUM LINES...**

□□ [Illustration 7] Disconnect the axle vacuum lines from the driver's side radius arm and from the passenger's side axle. {plastic fastener removal tool}

**9) DRIVE SHAFT...**

□ [Illustration 8] Mark the drive shaft orientation, then disconnect and tie drive shaft up and out of the way. {8mm}

**Illustration 4**

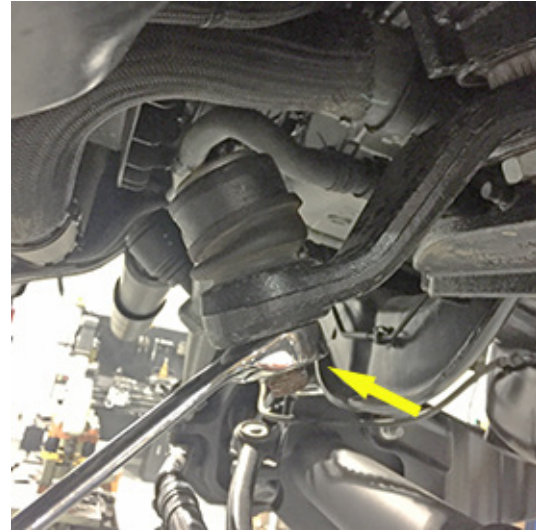

**Illustration 5**



**Illustration 6**



**Illustration 7**



**Illustration 8**



**10) SHOCK ABSORBERS...**

- [Illustration 9] Remove the lower bolt retaining the shock absorber to the axle. Disconnect the shock from the axle. {18mm}
  
- [Illustration 10] Remove the nut retaining the shock to the upper shock mount. {21mm}

**11) COIL SPRINGS...**

- Carefully lower the front axle enough to facilitate the removal of the front coil springs. Make sure no hoses or lines are in a bind when lowering the axle.

**Illustration 9****Illustration 10****12) TRACK BAR BRACKET...**

- [Illustration 11 & 12] Unbolt the factory track bar bracket from the frame and the crossmember. {frame 18mm, crossmember 21mm}

**Illustration 11****Illustration 12**

## **FRONT ASSEMBLY**

### **13) TRACK BAR BRACKET...**

Position the new track bar bracket (55-01-9062) on the frame in the factory position and secure using the factory hardware. Once all bolts and nuts have been started, tighten. (136) {frame 18mm, crossmember 21mm}

**NOTE:** Perform the following steps one side at a time. Start on the driver side.

**STANDARD KIT INSTRUCTIONS - If a Radius Arm Kit or 4-Link Kit were purchased, skip to the appropriate installation section.**

### **14) RADIUS ARMS...**

[Illustration 13] Unbolt the radius arm from the frame. {bolt 24mm, nut 27mm}

### **15) RADIUS ARM BRACKETS...**

[Illustration 14] Position the radius arm bracket (55-05-9090) inside the factory mount and secure using the supplied 18mm x 130mm bolt, nyloc nut, and washer through the rearward most hole. Insert the supplied 18mm x 130mm bolt through the forward most hole and secure with the nyloc nut, and washer. (230) {27mm}

**Illustration 13**



**Illustration 14**

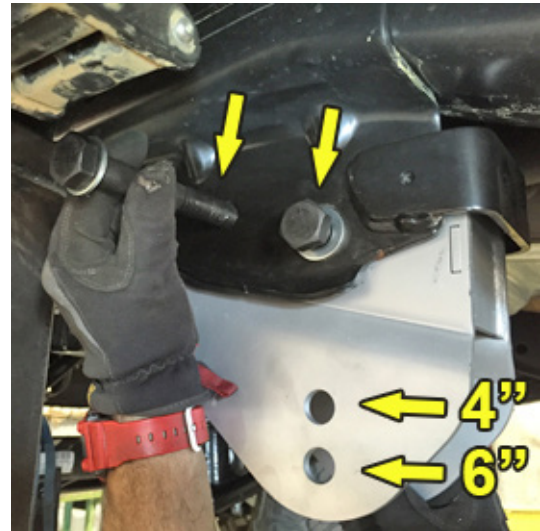

### **16) RADIUS ARMS...**

The new radius arm bracket used for 4" and 6" kits has two lower hole mounts for the OEM radius arm to bolt into proper position. The top hole is for 4" kits and the bottom hole is for 6" kits. Reattach the factory radius arm to the drop bracket and loosely secure using the factory hardware. Do not tighten at this time. {bolt 24mm, nut 27mm}

Move to Step 17.

**RADIUS ARM KIT INSTRUCTIONS - If a Standard Kit or 4-Link Kit were purchased, skip to the appropriate installation section.**

**14) FACTORY RADIUS ARMS...**

[Illustration 15] Unbolt the radius arm from the frame and the axle, then remove. {frame bolt 24mm, nut 27mm; axle 24mm}

**15) SUPERLIFT RADIUS ARMS...**

[Illustration 16] Attach the new radius arm (55-09-9000 driver's side; 55-10-9000 passenger's side) to the axle using the supplied 18mm x 130mm bolt at the top and the 18mm cam bolt (55-11-9000) and washer (55-21-9910) at the lower mount; loosely secure with the supplied nyloc nuts. Do not tighten at this time. {27mm}

Attach the new radius arm to the factory frame mount and loosely secure using the factory 18mm hardware. {bolt 24mm, nut 27mm}

Move to Step 17.

**Illustration 15**



**Illustration 16**

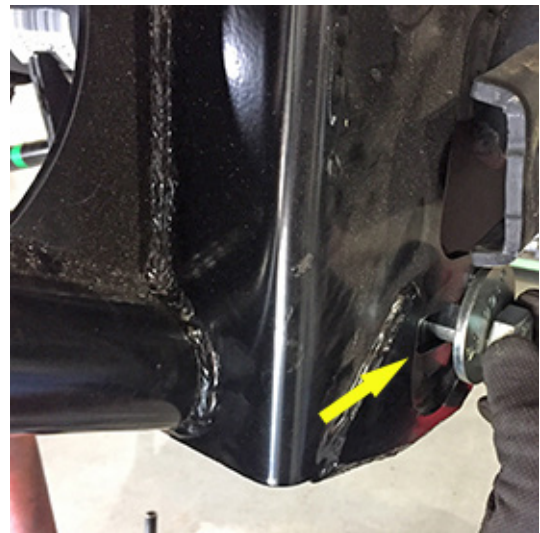

**4-LINK KIT INSTRUCTIONS - If a Standard Kit or Radius Arm Kit were purchased, skip to the appropriate installation section.**

**14) FACTORY RADIUS ARMS...**

[Illustration 17] Unbolt the radius arm from the frame and the axle, then remove. {frame bolt 24mm, nut 27mm; axle 24mm}

**15) 4-LINK FRAME BRACKETS...**

[Illustration 18] Position the radius arm bracket (55-25-9090) inside the factory mount and secure using the supplied 18mm x 130mm bolt, nyloc nut, and washer through the rearward most hole. {27mm}

**Illustration 17**



**16) 4-LINK ARMS...**

[Illustration 19] Install the new upper four link arm (55-07-9090) on the axle mount and loosely secure using the factory hardware. {24mm}

[Illustration 20] Install the new lower four link arm (55-08-9090) on the axle mount and loosely secure using the supplied 18mm x 130mm cam bolt (55-11-9000) and washers (55-21-9910). {27mm}

[Illustration 18] Attach the upper four link arm to the frame bracket using the supplied 18mm x 130mm bolt, washer, and stover nut. Do not tighten at this time. {27mm}

[Illustration 18] Attach the lower four link arm to the frame bracket using the supplied 18mm x 120mm bolt, washer, and stover nut. Do not tighten at this time. {27mm}

**Illustration 18**

Move to Step 17.

**Illustration 19****Illustration 20**

**COIL SPRING KIT INSTRUCTIONS - If a coilover kit was purchased, skip to the installation section below.**

**17) COIL SPRINGS... If a coilover kit was purchased, skip to the Coilover Kit instructions.**

With the coil spring isolator in place on the new coil spring (01-294), install the coil springs over the coil spring upper mount and onto the lower seat. Rotate coil spring until the coil is seated properly against the coil spring stop on the lower seat.

Raise the axle until the coil spring isolator is seated securely against the upper coil tower.

**18) SHOCK ABSORBERS...**

Install the one of the new supplied shock stem washers and bushings onto the stem of the new shock (Superide 01-88510 or Bilstein BE5-6681-H5). Insert the shock stem into the factory upper

shock mount and place the second bushing then washer onto the shock stem and secure using the supplied nut. Tighten until the bushing slightly swell.

Attach the lower shock eye to the axle in the factory location using the factory hardware. Do not tighten at this time. {18mm}

Move to Step 20.

### COILOVER KIT INSTRUCTIONS - If a coil spring kit was purchased, skip to Step 20.

#### 17) COIL SPRING AXLE SEATS...

[Illustration 21] Unbolt the lower coil mount from the axle and discard. {18mm}

#### 18) COILOVER AXLE MOUNT...

[Illustration 22] Make sure the coil spring axle seat is free from any dirt or debris. Mount the lower coilover bracket on the axle using the supplied hardware. (90)

#### 19) COILOVER FRAME MOUNT..

[Illustration 23] Place the reservoir mount, located in the SL5164 box, over the upper factory coil

**Illustration 21**



**Illustration 23**



**Illustration 22**



**Illustration 24**



**Illustration 25**



locating boss. Carefully mark the three hole locations. Remove the bracket and drill 7/16" holes in the three marked locations. **WARNING: Take extreme caution to not drill into anything located on top of the coil towers.**

□□ [Illustration 24] Cut the coil spring locating boss flush with the upper coil mount. Grind any remaining edges of the coil spring locating boss so there is a smooth mounting surface.

□□ Place the coilover into the lower mount and secure using the supplied hardware. (90)

□□ Insert the supplied 3/8" bolts into the holes in the coil tower. Note that the short (3/8" x 3/4") bolt goes in the outermost hole. Failure to have the bolts in the correct orientation can cause damage to the hose fitting on the coilover.

□□ [Illustration 25] Position the reservoir mount between the shock mount and the frame. Move the coilover into position and tighten the top mounting bolts. (45) Accessing these bolts through the engine compartment may be necessary.

□□ [Illustration 26] Center the reservoir in the mount and secure with the band clamps. Position the reservoir so hose is close to the inside of the wheel well and tighten.

□□ [Illustration 28] Bolt the ABS line and the brake lines to the lower mount, making sure there is adequate clearance to any moving parts.

Move to Step 20.

**Illustration 26**



**Illustration 27**

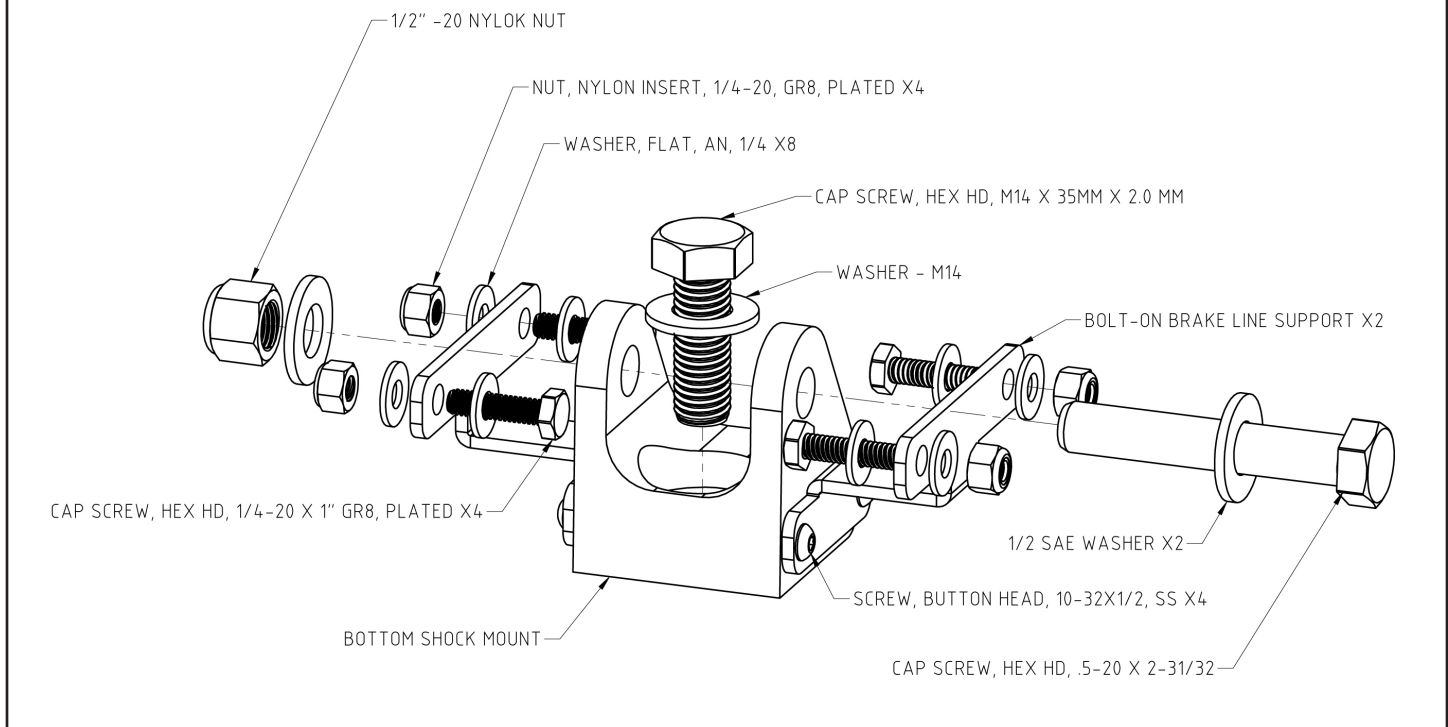

**Illustration 28****20) BRAKE LINE FRAME BRACKETS...**

□□ [Illustration 29 (driver) & 30 (passenger)] Install the new supplied brake line bracket (55-22-9090) to the frame using the factory hardware in the factory location. (18) {13mm}

□□ Install the supplied 1/4" x 1/2" self-tapping bolt into the top hole of the new brake line bracket. This bolt will not "thread" into the frame, rather it will act as a 'pin' to keep the bracket from spinning on the frame.

□□ [Illustration 29 (driver) & 30 (passenger)] Very carefully bend the brake lines so they can be attached to the new brake line bracket. DO NOT OVER BEND or KINK THE LINES. Attach the factory brake line bracket to the new frame bracket using the supplied 3/8" x 1" bolt, washer, and nyloc nut. (30) (9/16")

**Illustration 29****Illustration 30**



**21) BRAKE LINE AXLE BRACKETS...**

- □ Reattach the factory brake line axle bracket to the coil spring seat using the factory bolt. (40) {10mm}

**22) DRIVE SHAFT...**

- Realign the previously made mark on the drive shaft and install using the factory hardware. Apply thread locker to the bolts before installing. (11) {8mm}

**23) ABS and VENT ROUTING...**

- [Illustration 31] Disconnect the axle vent line from the frame, located on the driver's side frame rail under the engine mount. {plastic fastener removal tool}
- [Illustration 32] Disconnect the ABS line from the frame, located on the driver's side frame rail under the engine mount just above where the axle vent hose was attached. {plastic fastener removal tool}
- [Illustration 33 & 34] Reattach the ABS line to the frame in the axle vent line's factory location. Reattach the ABS line to the factory location on the radius arm.

**Illustration 31****Illustration 32****Illustration 33****Illustration 34**

- Reconnect the differential vent tube to the axle.

#### 24) BUMP STOP...

- Remove the factory bump stop from its mount. {pry bar}
- Remove the factory bump stop mount. {10mm}
- Place the new bump stop (55-15-9090) between the frame and the factory bump stop mount and secure to the frame using the supplied 8mm x 75mm bolt. Then reinstall the bump stop into its mount. (18) {13mm}

#### 25) TIRES / WHEELS...

- Tighten the lug nuts in the sequence shown. (151) {21mm}

**WARNING:** When the tires / wheels are installed, always check for and remove any corrosion, dirt, or foreign material on the wheel mounting surface, or anything that contacts the wheel mounting surface (hub, rotor, etc.). Installing wheels without the proper metal-to-metal contact at the wheel mounting surfaces can cause the lug nuts to loosen and the wheel to come off while the vehicle is in motion.

**WARNING:** Retighten lug nuts at 500 miles after any wheel change, or anytime the lug nuts are loosened. Failure to do so could cause wheels to come off while vehicle is in motion.

- Lower the vehicle to the floor.

#### 26) TRACK BAR...

- [Illustration 35] Observe the two supplied track bar keys and note that the hole in each key is offset to one side. Position the keys so that the holes are offset to the passenger side and insert them into the slotted holes of the track bar bracket. Insert the factory track bar bolt through the bracket, keys, and track bar and secure using the factory hardware. Tighten (406) {30mm}

**IMPORTANT:** Yes, the proper torque specification for the track bar eye bolt is 406 lb-ft; this is not a typographical error. If the appropriate torque wrench is not available, tighten the bolt as much as possible, then take the vehicle to the Ford Dealer or a heavy equipment repair shop to perform the final torque operation. Proper torque on this bolt is critical.

#### 27) SWAY BAR LINKS...

- [Illustration 36] Place the thick 1/2" washer over the sway bar link axle mounting hole and reconnect the sway bar links to the axle and tighten using the factory hardware. (100) {18mm}

**Illustration 35**



**Illustration 36**



**28) DRAG LINK...**

- Connect the drag link to the pitman arm using the factory castle nut and cotter pin. {24mm, pliers}

**29) STEERING STABILIZER BRACKET...**

- [Illustration 37] Install the new steering stabilizer bracket (55-21-9090) using the factory hardware. (37) {15mm}

- [Illustration 37] Attach the steering stabilizer to the new bracket using the supplied 7/16" x 2-1/2" bolt, washer, and nyloc nut. (50) {5/8"}

**30) HARDWARE TIGHTENING SEQUENCE...**

- Tighten the following hardware:

**Standard Kit**

- shock absorber to axle (105) {18mm}
- radius arm to frame (222) {bolt 24mm, nut 27mm}

**Radius Arm Kit**

- shock absorber to axle (105) {18mm}
- radius arm to axle (222) {upper 24mm, lower 27mm}
- radius arm to frame (222) {bolt 24mm, nut 27mm}

**4-Link Kit**

- shock absorber to axle (105) {18mm}
- 4-link arms to axle (222) {upper 24mm, lower 27mm}
- 4-link arms to frame (222) {bolt 24mm, nut 27mm}

**REAR DISASSEMBLY****31) RAISE REAR OF VEHICLE...**

- Chock the front tires. Position a jack beneath the center of the rear axle then raise rear of vehicle. Secure jack stands beneath the frame rails just forward of the rear springs. Remove rear tires.

**32) SHOCK ABSORBERS...**

- [Illustration 38] Unbolt the shock absorber from the lower mount. {bolt 18mm, nut 21mm}
- Unbolt the shock absorber from the upper mount and remove from vehicle. Discard. {18mm}

**33) BRAKE LINE BRACKET...**

- [Illustration 39 & 40] Remove the rear axle vent hose from the barbed fitting. Remove the barbed fitting and allow the brake line bracket to move freely from the axle. {plastic fastener removal tool, 16mm}

**Illustration 37****Illustration 38**

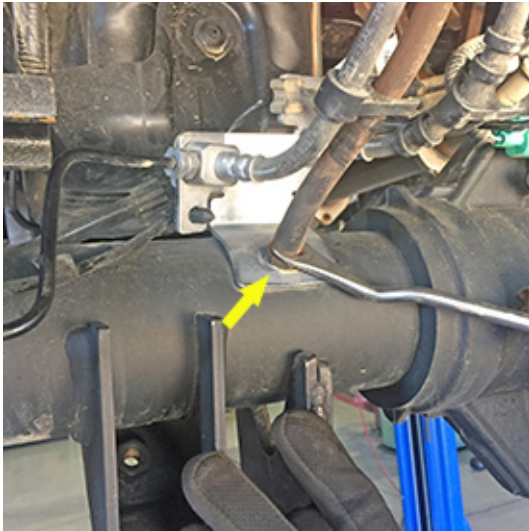
**Illustration 39****Illustration 40****34) UBOLTS AND BLOCKS...**

[Illustration 41] Using a floor jack support the rear axle and remove the u-bolts and discard. {24mm}

Lower the axle to remove the factory block. Make sure no brake or ABS lines are in a bind as you lower the axle.

**Illustration 41****REAR ASSEMBLY****35) LIFT BLOCKS AND UBOLTS...**

[Illustration 42] Install the new lift blocks (55-02-200). There is an indicator notch in the block that should face the front of the vehicle with the taller end of the block facing the rear. Make sure the locating pins are seated correctly. Jack the axle back into position while making sure that the axle pins are seated correctly into the block.

[Illustration 43] Install the new block shim (55-03-200) between the block and leaf spring, then place the supplied 7/16" ubolts over the leaf spring and through the shim and block. Do not tighten at this time.

[Illustration 44] Install the new ubolts (11962) using the supplied 9/16" washers and nuts; tighten using the "X" pattern. (210) {7/8"}

[Illustration 43] Install the supplied 7/16" flange nuts onto the 7/16" ubolts and tighten. (60) {5/8"}

**Illustration 42**

**Illustration 43****36) SHOCK ABSORBERS...**

Install the supplied 5/8" ID bushing into the eye of the shaft (upper) end and the 3/4" ID bushing into the eye of the body (lower) end. Insert the supplied sleeve into the eye ring on the body (lower) end and install onto vehicle using the factory bolts and nuts. NOTE: KING shocks are pre-assembled and ready to install. They are installed with the body up (frame) and shaft down (axle) (136) {bolt 18mm, nut 21mm}

**37) BRAKE LINE BRACKET...**

[Illustration 45] Install the new supplied brake line bracket (55-09-9074) onto the axle between the axle and the factory brake line bracket. Do not kink the brake lines. Secure using the barbed fitting. {16mm}

**38) AXLE VENT HOSE...**

[Illustration 45] Attach the vent hose to the barbed fitting.

**39) TIRES / WHEELS...**

Reinstall tires and wheels. Tighten the lug nuts in the sequence shown. (151) {21mm}

**WARNING:** When the tires / wheels are installed, always check for and remove any corrosion, dirt, or foreign material on the wheel mounting surface, or anything that contacts the wheel mounting surface (hub, rotor, etc.). Installing wheels without the proper metal-to-metal contact at the wheel mounting surfaces can cause the lug nuts to loosen and the wheel to come off while the vehicle is in motion.

**WARNING:** Retighten lug nuts at 500 miles after any wheel change, or anytime the lug nuts are loosened. Failure to do so could cause wheels to come off while vehicle is in motion.

Lower vehicle to the floor.

**40) CLEARANCE CHECK...**

With the vehicle on the ground, check all components for proper operation and clearances. Pay

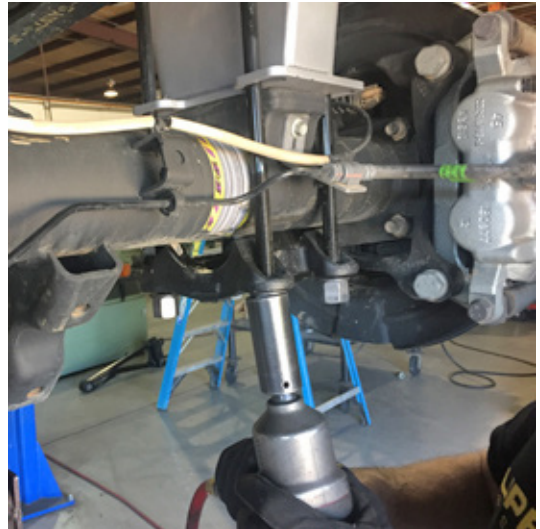
**Illustration 44****Illustration 45**

special attention to the clearance between the tires / wheels, brake hoses, wiring, etc.

#### **41) FOUR WHEEL DRIVE...**

- Activate four wheel drive system and check for proper engagement.

#### **42) ALIGNMENT...**

- A front end alignment is necessary after the installation of the radius arm and 4 link kits.

#### **43) HEADLIGHTS...**

- Re-adjust headlights to proper setting.

#### **44) SUPERLIFT WARNING DECAL...**

- Install the WARNING TO DRIVER decal on the inside of the windshield, or on the dash, within driver's view. Refer to the "NOTICE TO DEALER AND VEHICLE OWNER" section below.

#### **45) SUPERLIFT BADGES...**

- This kit is packaged with a Superlift badge. Prior to installation, use the supplied alcohol pad to eliminate all soap and other non-adhering residues that may impair adhesion, thoroughly clean the entire area of placement.
- The adhesive on our badges is pressure sensitive and must be applied using pressure on all areas of the graphic. Like any PSA (pressure sensitive adhesive), it can take up to 72 hours for the adhesive to fully cure. Once the badge is in place do not peel it up, this will diminish the adhesive properties and could result in damaging the badge itself.
- To keep your Superlift badge in "like new" appearance keep the badge free/clear of solvents and chemicals that could cause the adhesive to dry or dissolve. This includes gasoline, diesel fuel, paint thinner, and alcohol. Soap and water is all that is needed for cleaning. Degreasers can be used sparingly and hand whipped/applied if needed, although not suggested.

### **Important Maintenance Information**

It is the ultimate buyer's responsibility to have all bolts / nuts checked for tightness after the first 100 miles and then every 1000 miles. The steering, suspension and driveline systems, plus wheel alignment should be inspected by a qualified professional mechanic at least every 3000 miles.

### **Limited Lifetime Warranty / Warnings**

Your Superlift® product is covered by the Limited Warranty explained below that gives you specific legal rights. This limited warranty is the only warranty Superlift® makes in connection with your product purchase. Superlift® neither assumes nor authorizes any retailer or other person or entity to assume for it any other obligation or liability in connection with this product or limited warranty.

## Superlift, LLC, Limited Lifetime Warranty

What is covered? Subject to the terms below, Superlift® will repair or replace its products found defective in materials or workmanship for so long as the original purchaser owns the vehicle on which the product was originally installed. Your warrantor is Superlift, LLC, doing business as Superlift® Suspension Systems (“Superlift®”).

What is not covered? Your Superlift® Limited Warranty does not cover products Superlift® determines to have been damaged by or subjected to:

- Alteration, modification or failure to maintain.
- Normal wear and tear (bushings, rod ends, etc.). Scratches or defects in product finishes (powder coating, plating, etc.).
- Damage to, or resulting from, the vehicle’s electronic stability system, related components or other vehicle systems.
- Racing or other vehicle competitions or contests. Accidents, impact by rocks, trees, obstacles or other aspects of the environment.
- Theft, vandalism or other intentional damage.

Remedy Limited to Repair or Replacement. The exclusive remedy provided hereunder shall, upon Superlift’s inspection and at Superlift’s option, be either repair or replacement of the product covered under this Limited Warranty. Customers requesting warranty consideration should contact Superlift® by phone (1-800-551-4955) to obtain a Returned Goods Authorization number. All removal, shipping and installation costs are customer’s responsibility.

If a replacement part is needed before the Superlift® part in question can be returned, you must first purchase the replacement part. Then, if the part in question is deemed warrantable, you will be credited / refunded.

### **Other Limitations - Exclusion of Damages - Your Rights Under State Law**

- Neither Superlift® nor your independent Superlift® dealer are responsible for any time loss, rental costs, or for any incidental, consequential or other damages you may have.
- This Limited Warranty gives you specific rights, and this is the only warranty Superlift® makes in connection with your product purchase. You may also have other rights that vary from state to state. For example, while all implied warranties are disclaimed herein, any implied warranty required by law is limited to the terms of our Limited Lifetime Warranty as described above. Some states do not allow limitations of how long an implied warranty lasts and / or do not allow the exclusion or limitation of incidental or consequential damages, so the limitations and exclusions herein may not apply to you. Superlift® neither assumes nor authorizes any retailer or other person or entity to assume for it any other obligation or liability in connection with this product or Limited Warranty.

## Superlift, LLC, Satisfaction Guarantee

We want you to purchase our product with confidence and be 100% satisfied with the end result. If you have any legitimate issue, and Superlift® cannot rectify it to your satisfaction, Superlift® will take back the Superlift® brand product and refund the customer 100% of the product purchase price.

The details:

- Offer valid to the original retail consumer for six months after product purchase.
- May require a Superlift® dealer's participation in order to assist in "troubleshooting" the issue.
- Any costs related to labor, freight, incidental or consequential are not refunded.
- Refund will not exceed Superlift's® published retail price.

### Important Product Use and Safety Information / Warnings

As a general rule, the taller a vehicle is, the easier it will roll over. Offset, as much as possible, what is lost in rollover resistance by increasing tire track width. In other words, go "wide" as you go "tall"; always use as wide a tire and wheel combination as feasible to enhance vehicle stability. We strongly recommend, because of rollover possibility, that the vehicle be equipped with a functional roll bar and cage system. Seat belts and shoulder harnesses should be worn at all times. Avoid situations where a side rollover may occur.

Generally, braking performance and capabilities are decreased when significantly larger / heavier tires and wheels are used. Take this into consideration while driving. Also, changing axle gear ratios or using tires that are taller or shorter than factory height will cause an erroneous speedometer reading. On vehicles equipped with an electronic speedometer, the speed signal impacts other important functions as well. Speedometer recalibration for both mechanical and electronic types is highly recommended.

Do not add, alter, or fabricate any factory or aftermarket parts to increase vehicle height over the intended height of the Superlift® product purchased. Mixing component brands is not recommended.

### **SUPERLIFT SUSPENSION**

300 Huey Lenard Loop Rd.  
West Monroe, Louisiana 71292  
Phone: (318) 397-3000  
Sales / Tech: (800) 551-4955  
Fax: (318) 397-3040  
[www.superlift.com](http://www.superlift.com)