



SUPERLIFT®

S U S P E N S I O N

2017 FORD F250 / F350 6” (STANDARD, RADIUS ARM, AND 4-LINK; COIL SPRING AND COILOVER) INSTALLATION INSTRUCTIONS

THANK YOU FOR CHOOSING SUPERLIFT FOR ALL YOUR SUSPENSION NEEDS!!

INTRODUCTION

Installation requires a professional mechanic.

Prior to beginning, inspect the vehicles steering, driveline, and brake systems, paying close attention to the suspension link arms and bushings, sway bars and bushings, tie rod ends, pitman arm, ball joints and wheel bearings. Also check the steering sector-to-frame and all suspension-to-frame attaching points for stress cracks. The overall vehicle must be in excellent working condition; repair or replace all worn parts.

Read instructions several times before starting. Be sure you have all needed parts and know where they install. Read each step completely as you go.

NOTES:

- Prior to beginning the installation, check all parts and hardware in the box with the parts list below. If you find a packaging error, contact Superlift® directly. Do not contact the dealer where the system was originally purchased. You will need the control number from each box when calling; this number is located at the bottom of the part number label and to the right of the bar code.
- Front end alignment is necessary.
- A foot-pound torque reading is given in parenthesis () after each appropriate fastener.
- Tool and Wrench/Socket size is given in brackets { } after each appropriate step.
- Prior to attaching components, be sure all mating surfaces are free of grit, grease, excessive undercoating, etc.
- A factory service manual should be on hand for reference.
- Use the check-off box “” found at each step to help you keep your place. Two “” denotes that one check-off box is for the driver side and one is for the passenger side. Unless otherwise noted, always start with the driver side.

STANDARD KIT (RADIUS ARM DROP)

K KIT BREAKDOWN		
Kit Part Number K167		
Part Number	Qty.	Part Description
296	1	front coil springs, diesel
9092	1	radius arm drops
9095	1	front and rear shock absorbers
9101	1	stabilizer and brake line brackets
9103	1	sway bar and bump stop brackets
9102	1	track bar bracket
9100	1	rear block kit

KIT BREAKDOWN					
Kit Part Number 296			Kit Part Number 9103		
Part Number	Qty.	Part Description	Part Number	Qty.	Part Description
01-296	2	front coil springs, diesel	55-03-9074	1	sway bar bracket, passenger side
Kit Part Number 9092			55-04-9074	1	sway bar bracket, driver side
Part Number Qty. Part Description			55-09-9090	1	bump stop, driver side front half
55-05-9090	2	radius arm drop	55-10-9090	1	bump stop, driver side rear half
77-9092	1	hardware bag, radius arm drop	55-23-9090	1	bump stop, passenger side front half
Kit Part Number 9095			55-24-9090	1	bump stop, passenger side rear half
Part Number Qty. Part Description			77-9103	1	hardware bag
01-88510	2	shock cylinder, front Superide	Kit Part Number 9102		
01-85160	2	shock cylinder, rear Superide	Part Number Qty. Part Description		
77-9095	1	hardware bag	01-1116	1	pitman arm
Kit Part Number 9101			55-03-9066	1	track bar bracket
Part Number Qty. Part Description			77-9070-1	1	hardware bag, keys and nut
55-18-9090	1	stabilizer bracket, frame mount	Kit Part Number 9100		
55-19-9090	1	stabilizer bracket, drag link mount	Part Number Qty. Part Description		
55-09-9074	1	brake line bracket, rear	55-01-200	2	rear block, 7"
77-9093-1	1	hardware bag, front brake line bracket	55-03-200	2	rear block shim plate
77-9101	1	hardware bag	77-1505	1	5/8" ubolt nuts and washers
			77-1507	1	7/16" ubolts, nuts, and washers
			11722	4	5/8" x 3-1/4" x 17" ubolt, large radius

HARDWARE BAG BREAKDOWN					
Kit Part Number 77-9092			Kit Part Number 77-9099		
Part Number	Qty.	Part Description	Part Number	Qty.	Part Description
18mx2.5x130cs	4	18mm x 2.5 x 130mm bolt, 2.5 pitch	8mx1.25x75cs	2	8mm x 75mm bolt, 1.25 pitch
18mfw	8	18mm flat washer	716x1c5cs	1	7/16" x 1" bolt, coarse thread
18mnn	4	18mm nyloc nut, 2.5 pitch	716sw	2	7/16" sae washer
55-20-9090	2	sleeve, 1.125" OD x 0.188 wall x 2.736 long	716c5nn	1	7/16" nyloc nut, coarse thread
Kit Part Number 77-9093			Kit Part Number 77-1509		
Part Number Qty. Part Description			Part Number Qty. Part Description		
55-05-9024	2	track bar keys	1511-B09	8	9/16" ubolt nut
Kit Part Number 77-9093-1			916cw	8	9/16" ubolt washer
Part Number Qty. Part Description			Kit Part Number 77-1507		
55-22-9090	2	brake line bracket, front	Part Number Qty. Part Description		
38x1c5cs	2	3/8" x 1" bolt, coarse thread	716x314x412ub	4	7/16" x 3-1/4" x 4-1/2" ubolt, square
38sw	2	3/8" sae washer	716f8sfn	8	7/16" flange nut, fine thread
38c5nn	2	3/8" nyloc nut, coarse thread	Kit Part Number 77-9103		
14x12stb	1	1/4" x 1/2" bolt, self tapping	Part Number Qty. Part Description		
716x212c5cs	1	7/16" x 2-1/2" bolt, coarse thread	716x112c5cs	4	7/16" x 1-1/2" bolt, coarse thread
716sw	1	7/16" sae washer	716c5nn	4	7/16" nyloc nut, coarse thread
716c5nn	1	7/16" nyloc nut, coarse thread	716sw	4	7/16" sae washer
f470l	1	thread locking compound	8mx1.25x25cs	2	8mm x 25mm bolt, 1.25 pitch
Kit Part Number 77-9101			8mfw	2	8mm flat washer
Part Number Qty. Part Description			38x1c5cb	2	3/8" x 1" carriage bolt, coarse thread
916x214c5cs	1	9/16" x 2-1/4" bolt, coarse thread	38sw	2	3/8" sae washer
916c5nn	1	9/16" nyloc nut, coarse thread	38c5fn	2	3/8" flange nut, coarse thread
716x212c5cs	1	7/16" x 2-1/2" bolt, coarse thread	Kit Part Number 77-9070-1		
716x1c5cs	1	7/16" x 1" bolt, coarse thread	Part Number Qty. Part Description		
716sw	3	7/16" sae washer	30mx1.5jn	1	30mm jam nut, 1.5 pitch
716c5nn	2	7/16" nyloc nut, coarse thread	55-05-9024	2	track bar keys
Kit Part Number 77-9095			18x2cp	1	1/8" x 2" cotter pin
Part Number Qty. Part Description					
142731	2	shock stem hardware bag			
01-60416	2	5/8" ID bushing			
01-60418	2	3/4" ID bushing			
19-5040	2	sleeve, 0.75" OD x 0.565" ID x 1.48" Long			

STANDARD KIT (RADIUS ARM DROP)

Step	Part Number	Qty. per Kit	Description	New Attaching Hardware	Qty. per Bracket	Hardware Bag Number
14	01-1116	1	pitman arm	30mm jam nut, 1.5 pitch	1	77-9070-1
				1/8" x 2" cotter pin	1	
15	55-03-9066	1	track bar bracket	55-05-9024 - track bar keys	2	77-9070-1
17	55-05-9090	2	radius arm drop	18mm x 2.5 x 130mm bolt, 2.5 pitch	2	77-9092
				18mm flat washer	4	
				18mm nyloc nut, 2.5 pitch	2	
19	01-296	2	coil springs, diesel			
20	01-88510	2	shock cylinder, front Superide	142731 - shock stem hardware bag	1	77-9095
22	55-22-9090	2	brake line bracket, front	3/8" x 1" bolt, coarse thread	2	77-9093-1
				3/8" sae washer	2	
				3/8" nyloc nut, coarse thread	2	
				1/4" x 1/2" bolt, self tapping	1	
25	55-09-9090	1	sway bar bracket, driver's side front half	8mm x 25mm bolt, 1.25 pitch	2	77-9103
				8mm flat washer	2	
25	55-10-9090	1	bump stop bracket, driver's side rear half	3/8" x 1" carriage bolt, coarse thread	1	77-9103
				3/8" sae washer	1	
				3/8" flange nut, coarse thread	1	
25	55-23-9090	1	bump stop bracket, passenger's side front half	8mm x 25mm bolt, 1.25 pitch	2	77-9103
				8mm flat washer	2	
25	55-24-9090	1	bump stop bracket, passenger's side rear half	3/8" x 1" carriage bolt, coarse thread	1	77-9103
				3/8" sae washer	1	
				3/8" flange nut, coarse thread	1	
28	55-03-9074	1	sway bar bracket, passenger's side	7/16" X 1-1/2" bolt, coarse thread	2	77-9103
				7/16" nyloc nut, coarse thread	2	
				7/16" sae washer	2	
28	55-04-9074	1	sway bar bracket, driver's side	7/16" X 1-1/2" bolt, coarse thread	2	77-9103
				7/16" nyloc nut, coarse thread	2	
				7/16" sae washer	2	
30	55-18-9090	1	stabilizer bracket, frame mount	7/16" x 2-1/2" bolt, coarse thread	1	77-9101
				7/16" nyloc nut, coarse thread	1	
				7/16" sae washer	1	
30	55-19-9090	1	stabilizer bracket, drag link mount	9/16" x 2-1/4" bolt, coarse thread	1	77-9101
				9/16" nyloc nut, coarse thread	1	
34	55-01-200	2	rear block, 7"	11722 - 5/8" x 3-1/4" x 15" ubolt, large radius	2	77-1507
				55-03-200 - block shim plate	2	
				7/16" x 3-1/4" x 4-1/2" ubolt, square	2	
				7/16" flange nut, fine thread	4	
				5/8" ubolt nut	4	
				5/8" ubolt washer	4	77-1505
35	01-85160	2	shock cylinder, rear Superide	01-60416 - 5/8" ID bushing	1	77-9095
				01-60418 - 3/4" ID bushing	1	
				19-5040 - sleeve, 0.75" OD x 0.565" ID x 1.48" Long	2	
36	55-09-9074	1	brake line bracket, rear	7/16" x 1" bolt, coarse thread	1	77-9101
				7/16" sae washer	2	
				7/16" nyloc nut, coarse thread	1	

RADIUS ARM KIT

K KIT BREAKDOWN					
Kit Part Number K169			Kit Part Number K169KG		
Part Number	Qty.	Part Description	Part Number	Qty.	Part Description
296	1	front coil springs, diesel	SL5146-01	1	front coilovers
9500	1	radius arm	SL5171-01	1	rear shock absorbers
9095	1	front and rear shock absorbers	9101	1	stabilizer and brake line brackets
9101	1	stabilizer and brake line brackets	9103	1	sway bar and bump stop brackets
9103	1	sway bar and bump stop brackets	9102	1	track bar bracket
9102	1	track bar bracket	9100	1	rear block kit
9100	1	rear block kit	9500	1	radius arm

KIT BREAKDOWN					
Kit Part Number 296			Kit Part Number 9103		
Part Number	Qty.	Part Description	Part Number	Qty.	Part Description
01-296	2	front coil springs, diesel	55-03-9074	1	sway bar bracket, passenger side
Kit Part Number 9500			55-04-9074	1	sway bar bracket, driver side
Part Number Qty. Part Description			55-09-9090	1	bump stop, driver side front half
66-09-9000	1	radius arm, driver side	55-10-9090	1	bump stop, driver side rear half
66-10-9000	1	radius arm, passenger side	55-23-9090	1	bump stop, passenger side front half
77-9500	1	hardware bag, cam bolts	55-24-9090	1	bump stop, passenger side rear half
Kit Part Number 9095			77-9103	1	hardware bag
Part Number Qty. Part Description			Kit Part Number 9102		
01-88510	2	shock cylinder, front Superide	01-1116	1	pitman arm
01-85160	2	shock cylinder, rear Superide	55-03-9066	1	track bar bracket
77-9095	1	hardware bag	77-9070-1	1	hardware bag, keys and nut
Kit Part Number 9101			Kit Part Number 9100		
Part Number Qty. Part Description			55-01-200	2	rear block, 7"
55-18-9090	1	stabilizer bracket, frame mount	55-03-200	2	rear block shim plate
55-19-9090	1	stabilizer bracket, drag link mount	77-1505	1	5/8" ubolt nuts and washers
55-09-9074	1	brake line bracket, rear	77-1507	1	7/16" ubolts, nuts, and washers
77-9093-1	1	hardware bag, front brake line bracket	11722	4	5/8" x 3-1/4" x 17" ubolt, large radius
77-9101	1	hardware bag			

HARDWARE BAG BREAKDOWN					
Kit Part Number 77-9093-1			Kit Part Number 77-9095		
Part Number	Qty.	Part Description	Part Number	Qty.	Part Description
55-22-9090	2	brake line bracket, front	142731	2	shock stem hardware bag
38x1c5cs	2	3/8" x 1" bolt, coarse thread	01-60416	2	5/8" ID bushing
38sw	2	3/8" sae washer	01-60418	2	3/4" ID bushing
38c5nn	2	3/8" nyloc nut, coarse thread	19-5040	2	sleeve, 0.75" OD x 0.565" ID x 1.48" Long
14x12stb	1	1/4" x 1/2" bolt, self tapping	Kit Part Number 77-1505		
716x212c5cs	1	7/16" x 2-1/2" bolt, coarse thread	Part Number Qty. Part Description		
716sw	1	7/16" sae washer	1511-B10	8	5/8" ubolt nut
716c5nn	1	7/16" nyloc nut, coarse thread	58cw	8	5/8" ubolt washer
f470l	1	thread locking compound	Kit Part Number 77-1507		
Kit Part Number 77-9500			Part Number Qty. Part Description		
18mx2.5x140cs	2	18mm x 140mm bolt, 2.5 pitch	716x314x412ub	4	7/16" x 3-1/4" x 4-1/2" ubolt, square
18mfw	5	18mm flat washer	716f8sfn	8	7/16" flange nut, fine thread
18mln	4	18mm stover nut	Kit Part Number 77-9103		
55-11-9000	2	cam bolt	Part Number Qty. Part Description		
55-21-9910	4	cam washer	716x112c5cs	4	7/16" x 1-1/2" bolt, coarse thread
1112ct	4	zip tie	716c5nn	4	7/16" nyloc nut, coarse thread
Kit Part Number 77-9101			716sw	4	7/16" sae washer
Part Number Qty. Part Description			8mx1.25x25cs	2	8mm x 25mm bolt, 1.25 pitch
916x214c5cs	1	9/16" x 2-1/4" bolt, coarse thread	8mfw	2	8mm flat washer
916c5nn	1	9/16" nyloc nut, coarse thread	38x1c5cb	2	3/8" x 1" carriage bolt, coarse thread
716x212c5cs	1	7/16" x 2-1/2" bolt, coarse thread	38sw	2	3/8" sae washer
716x1c5cs	1	7/16" x 1" bolt, coarse thread	38c5fn	2	3/8" flange nut, coarse thread
716sw	3	7/16" sae washer	Kit Part Number 77-9070-1		
716c5nn	2	7/16" nyloc nut, coarse thread	Part Number Qty. Part Description		
Kit Part Number 77-9102			30mx1.5jn	1	30mm jam nut, 1.5 pitch
Part Number Qty. Part Description			55-05-9024	2	track bar keys
Kit Part Number 9100			18x2cpc	1	1/8" x 2" cotter pin
Part Number Qty. Part Description					

RADIUS ARM KIT

Step	Part Number	Qty. per Kit	Description	New Attaching Hardware	Qty. per Bracket	Hardware Bag Number
14	01-1116	1	pitman arm	30mm jam nut, 1.5 pitch	1	77-9070-1
				1/8" x 2" cotter pin	1	
15	55-03-9066	1	track bar bracket	55-05-9024 - track bar keys	2	77-9070-1
17	66-09-9000	1	radius arm, driver side	18mm x 2.5 x 130mm bolt, 2.5 pitch	1	77-9500
				18mm flat washer	2	
				18mm nyloc nut, 2.5 pitch	2	
				55-11-9000 - cam bolt	1	
				55-21-9910 - cam washer	2	
17	66-10-9000	1	radius arm, passenger side	18mm x 2.5 x 130mm bolt, 2.5 pitch	1	77-9500
				18mm flat washer	2	
				18mm nyloc nut, 2.5 pitch	2	
				55-11-9000 - cam bolt	1	
				55-21-9910 - cam washer	2	
19	01-296	2	coil springs, diesel			
	or SL5146-01	2	coilover shock, King			
20	01-88510	2	shock cylinder, front Superide	142731 - shock stem hardware bag	1	77-9095
22	55-22-9090	2	brake line bracket, front	3/8" x 1" bolt, coarse thread	2	77-9093-1
				3/8" sae washer	2	
				3/8" nyloc nut, coarse thread	2	
				1/4" x 1/2" bolt, self tapping	1	
25	55-09-9090	1	sway bar bracket, driver's side front half	8mm x 25mm bolt, 1.25 pitch	2	77-9103
				8mm flat washer	2	
25	55-10-9090	1	bump stop bracket, driver's side rear half	3/8" x 1" carriage bolt, coarse thread	1	77-9103
				3/8" sae washer	1	
				3/8" flange nut, coarse thread	1	
25	55-23-9090	1	bump stop bracket, passenger's side front half	8mm x 25mm bolt, 1.25 pitch	2	77-9103
				8mm flat washer	2	
25	55-24-9090	1	bump stop bracket, passenger's side rear half	3/8" x 1" carriage bolt, coarse thread	1	77-9103
				3/8" sae washer	1	
				3/8" flange nut, coarse thread	1	
28	55-03-9074	1	sway bar bracket, passenger's side	7/16" x 1-1/2" bolt, coarse thread	2	77-9103
				7/16" nyloc nut, coarse thread	2	
				7/16" sae washer	2	
28	55-04-9074	1	sway bar bracket, driver's side	7/16" x 1-1/2" bolt, coarse thread	2	77-9103
				7/16" nyloc nut, coarse thread	2	
				7/16" sae washer	2	
30	55-18-9090	1	stabilizer bracket, frame mount	7/16" x 2-1/2" bolt, coarse thread	1	77-9101
				7/16" nyloc nut, coarse thread	1	
				7/16" sae washer	1	
30	55-19-9090	1	stabilizer bracket, drag link mount	9/16" x 2-1/4" bolt, coarse thread	1	77-9101
				9/16" nyloc nut, coarse thread	1	
34	55-01-200	2	rear block, 7"	11722 - 5/8" x 3-1/4" x 15" ubolt, large radius	2	77-1507
				55-03-200 - block shim plate	2	
				7/16" x 3-1/4" x 4-1/2" ubolt, square	2	
				7/16" flange nut, fine thread	4	
				5/8" ubolt nut	4	
35	01-85160	2	shock cylinder, rear Superide	01-60416 - 5/8" ID bushing	1	77-9095
	or SL5171-01	2	shock cylinder, rear King	01-60418 - 3/4" ID bushing 19-5040 - sleeve, 0.75" OD x 0.565" ID x 1.48" Long	1 2	
36	55-09-9074	1	brake line bracket, rear	7/16" x 1" bolt, coarse thread	1	77-9099
				7/16" sae washer	2	
				7/16" nyloc nut, coarse thread	1	

4-LINK KIT

K KIT BREAKDOWN					
Kit Part Number K171			Kit Part Number K171KG		
Part Number	Qty.	Part Description	Part Number	Qty.	Part Description
296	1	front coil springs, diesel	SL5146-01	1	front coilovers
9104	1	radius arm drops	SL5171-01	1	rear shock absorbers
9095	1	front and rear shock absorbers	9101	1	stabilizer and brake line brackets
9101	1	stabilizer and brake line brackets	9103	1	sway bar and bump stop brackets
9103	1	sway bar and bump stop brackets	9102	1	track bar bracket
9102	1	track bar bracket	9100	1	rear block kit
9100	1	rear block kit	9096	1	lower 4-links
9096	1	lower 4-links	9098	1	upper 4-links
9098	1	upper 4-links	9104	1	radius arm drops

KIT BREAKDOWN					
Kit Part Number 296			Kit Part Number 9103		
Part Number	Qty.	Part Description	Part Number	Qty.	Part Description
01-296	2	front coil springs, diesel	55-03-9074	1	sway bar bracket, passenger side
Kit Part Number 9104			55-04-9074	1	sway bar bracket, driver side
Part Number Qty. Part Description			55-09-9090	1	bump stop, driver side front half
55-25-9090	2	radius arm drops, 4 link	55-10-9090	1	bump stop, driver side rear half
77-9104	1	hardware bag	55-23-9090	1	bump stop, passenger side front half
Kit Part Number 9095			55-24-9090	1	bump stop, passenger side rear half
Part Number Qty. Part Description			77-9103	1	hardware bag
01-88510	2	shock cylinder, front Superide	Kit Part Number 9102		
01-85160	2	shock cylinder, rear Superide	01-1116	1	pitman arm
77-9095	1	hardware bag	55-03-9066	1	track bar bracket
Kit Part Number 9101			77-9070-1	1	hardware bag, keys and nut
Part Number Qty. Part Description			Kit Part Number 9100		
55-18-9090	1	stabilizer bracket, frame mount	55-01-200	2	rear block, 7"
55-19-9090	1	stabilizer bracket, drag link mount	55-03-200	2	rear block shim plate
55-09-9074	1	brake line bracket, rear	77-1505	1	5/8" ubolt nuts and washers
77-9093-1	1	hardware bag, front brake line bracket	77-1507	1	7/16" ubolts, nuts, and washers
77-9101	1	hardware bag	11722	4	5/8" x 3-1/4" x 17" ubolt, large radius
Kit Part Number 9096			Kit Part Number 9098		
Part Number Qty. Part Description			Part Number Qty. Part Description		
55-08-9090	2	link arm, lower	55-07-9090	2	link arm, upper
77-9500	1	hardware bag, cam bolts			

HARDWARE BAG BREAKDOWN					
Kit Part Number 77-9093-1			Kit Part Number 77-9095		
Part Number	Qty.	Part Description	Part Number	Qty.	Part Description
55-22-9090	2	brake line bracket, front	142731	2	shock stem hardware bag
38x1c5cs	2	3/8" x 1" bolt, coarse thread	01-60416	2	5/8" ID bushing
38sw	2	3/8" sae washer	01-60418	2	3/4" ID bushing
38c5nn	2	3/8" nyloc nut, coarse thread	19-5040	2	sleeve, 0.75" OD x 0.565" ID x 1.48" Long
14x12stb	1	1/4" x 1/2" bolt, self tapping	Kit Part Number 77-1509		
716x212c5cs	1	7/16" x 2-1/2" bolt, coarse thread	Part Number Qty. Part Description		
716sw	1	7/16" sae washer	1511-B09	8	9/16" ubolt nut
716c5nn	1	7/16" nyloc nut, coarse thread	916cw	8	9/16" ubolt washer
f470l	1	thread locking compound	Kit Part Number 77-1507		
Kit Part Number 77-9500			Part Number Qty. Part Description		
Part Number Qty. Part Description			716x314x412ub	4	7/16" x 3-1/4" x 4-1/2" ubolt, square
18mx2.5x140cs	2	18mm x 140mm bolt, 2.5 pitch	716f8sfm	8	7/16" flange nut, fine thread
18mfw	5	18mm flat washer	Kit Part Number 77-9103		
18mln	4	18mm stover nut	Part Number Qty. Part Description		
55-11-9000	2	cam bolt	716x112c5cs	4	7/16" x 1-1/2" bolt, coarse thread
55-21-9910	4	cam washer	716c5nn	4	7/16" nyloc nut, coarse thread
1112ct	4	zip tie	716sw	4	7/16" sae washer
Kit Part Number 77-9101			8mx1.25x25cs	2	8mm x 25mm bolt, 1.25 pitch
Part Number Qty. Part Description			8mfw	2	8mm flat washer
916x214c5cs	1	9/16" x 2-1/4" bolt, coarse thread	38x1c5cb	2	3/8" x 1" carriage bolt, coarse thread
916c5nn	1	9/16" nyloc nut, coarse thread	38sw	2	3/8" sae washer
716x212c5cs	1	7/16" x 2-1/2" bolt, coarse thread	38c5fn	2	3/8" flange nut, coarse thread
716x1c5cs	1	7/16" x 1" bolt, coarse thread	Kit Part Number 77-9070-1		
716sw	3	7/16" sae washer	Part Number Qty. Part Description		
716c5nn	2	7/16" nyloc nut, coarse thread	30mx1.5jn	1	30mm jam nut, 1.5 pitch
Kit Part Number 77-9104			55-05-9024	2	track bar keys
Part Number Qty. Part Description			18x2cp	1	1/8" x 2" cotter pin
18mx2.5x120cs	2	18mm x 120mm bolt, 2.5 pitch			
18mln	2	18mm stover nut			

4-LINK KIT

Step	Part Number	Qty. per Kit	Description	New Attaching Hardware	Qty. per Bracket	Hardware Bag Number
14	01-1116	1	pitman arm	30mm jam nut, 1.5 pitch	1	77-9070-1
				1/8" x 2" cotter pin	1	
15	55-03-9066	1	track bar bracket	55-05-9024 - track bar keys	2	77-9093
17	55-25-9090	2	radius arm, 4 link	18mm x 2.5 x 130mm bolt, 2.5 pitch	1	77-9500
				18mm flat washer	2	
				18mm nyloc nut, 2.5 pitch	3	77-9104
				18mm x 2.5 x 120mm bolt, 2.5 pitch	1	
18	55-08-9090	2	link arm, lower	55-11-9000 - cam bolt	1	77-9500
				55-21-9910 - cam washer	2	
18	55-07-9090	2	link arm, upper			
19	01-296 or SL5146-01	2	coil springs, diesel coilover shock, King			
20	01-88510 or BE5-6681-H5	2	shock cylinder, front Superide shock cylinder, front Bilstein	142731 - shock stem hardware bag	1	77-9095
22	55-22-9090	2	brake line bracket, front	3/8" x 1" bolt, coarse thread	2	77-9093-1
				3/8" sae washer	2	
				3/8" nyloc nut, coarse thread	2	
				1/4" x 1/2" bolt, self tapping	1	
25	55-09-9090	1	sway bar bracket, driver's side front half	8mm x 25mm bolt, 1.25 pitch	2	77-9103
				8mm flat washer	2	
25	55-10-9090	1	bump stop bracket, driver's side rear half	3/8" x 1" carriage bolt, coarse thread	1	77-9103
				3/8" sae washer	1	
				3/8" flange nut, coarse thread	1	
25	55-23-9090	1	bump stop bracket, passenger's side front half	8mm x 25mm bolt, 1.25 pitch	2	77-9103
				8mm flat washer	2	
25	55-24-9090	1	bump stop bracket, passenger's side rear half	3/8" x 1" carriage bolt, coarse thread	1	77-9103
				3/8" sae washer	1	
				3/8" flange nut, coarse thread	1	
28	55-03-9074	1	sway bar bracket, passenger's side	7/16" X 1-1/2" bolt, coarse thread	2	77-9103
				7/16" nyloc nut, coarse thread	2	
				7/16" sae washer	2	
28	55-04-9074	1	sway bar bracket, driver's side	7/16" X 1-1/2" bolt, coarse thread	2	77-9103
				7/16" nyloc nut, coarse thread	2	
				7/16" sae washer	2	
30	55-18-9090	1	stabilizer bracket, frame mount	7/16" x 2-1/2" bolt, coarse thread	1	77-9101
				7/16" nyloc nut, coarse thread	1	
				7/16" sae washer	1	
30	55-19-9090	1	stabilizer bracket, drag link mount	9/16" x 2-1/4" bolt, coarse thread	1	77-9101
				9/16" nyloc nut, coarse thread	1	
34	55-01-200	2	rear block, 7"	11722 - 5/8" x 3-1/4" x 15" ubolt, large radius	2	77-1507
				55-03-200 - block shim plate	2	
				55-20-9074 - top ubolt plate	1	
				7/16" x 3-1/4" x 4-1/2" ubolt, square	2	
				7/16" flange nut, fine thread	4	
				5/8" ubolt nut	4	
35	01-85160 or SL5171-01	2	shock cylinder, rear Superide shock cylinder, rear King	01-60416 - 5/8" ID bushing	1	77-9095
				01-60418 - 3/4" ID bushing	1	
36	55-09-9074	1	brake line bracket, rear	19-5040 - sleeve, 0.75" OD x 0.565" ID x 1.48" Long	2	77-9099
36	55-09-9074	1	brake line bracket, rear	7/16" x 1" bolt, coarse thread	1	77-9099
				7/16" sae washer	2	
				7/16" nyloc nut, coarse thread	1	

FRONT DISASSEMBLY

NOTE: Save all factory components and hardware for reuse, unless noted.

1) TRACK BAR...

[Illustration 1] Prior to raising the vehicle, disconnect the track bar from its attachment point on the frame and let the bar hang. {30mm}

2) SWAY BAR LINKS...

[Illustration 2] Disconnect the sway bar links for their attachment points on the sway bar. {18mm}

Illustration 1



Illustration 2

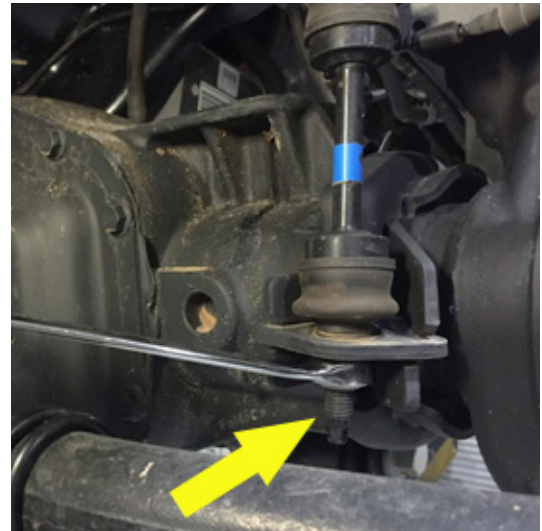

3) PREPARE VEHICLE...

Chock rear tires and place transmission in neutral. Raise front of vehicle with a jack and secure a jack stand beneath each frame rail, behind the radius arm mounts. Ease the frame down onto the stands and place transmission in park. Remove front tires. {Lug Nuts 21mm}

Perform steps 4 through 9 one side at a time.

4) STEERING STABILIZER...

Disconnect the steering stabilizer from the frame bracket and the drag link. {15mm}

[Illustration 3] Remove the steering stabilizer from the frame. {13mm}

5) DRAG LINK...

[Illustration 4] Remove the cotter pin and castle nut from the drag link, then using the appropriate puller tool, disconnect the drag link from the pitman arm. {pliers, 24mm}

6) BRAKE LINE BRACKETS...

[Illustration 5] Remove the bolt holding the brake line bracket to the axle. {10mm}

Illustration 3



□□ [Illustration 6] Remove the bolt retaining the brake line bracket to the frame. {13mm}

7) DIFFERENTIAL VENT HOSE...

□ Disconnect the vent hose from the axle. {plastic fastener removal tool}

8) AXLE VACUUM LINES...

□□ [Illustration 7] Disconnect the axle vacuum lines from the driver's side radius arm and from the passenger's side axle. {plastic fastener removal tool}

9) DRIVE SHAFT...

□ [Illustration 8] Mark the drive shaft orientation, then disconnect and tie drive shaft up and out of the way. {8mm}

Illustration 4

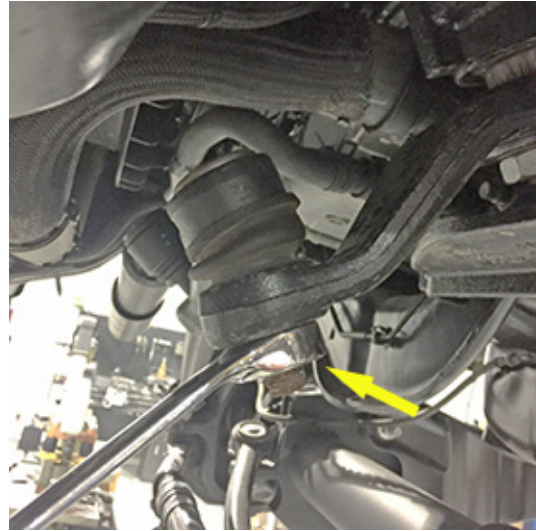

Illustration 5



Illustration 6

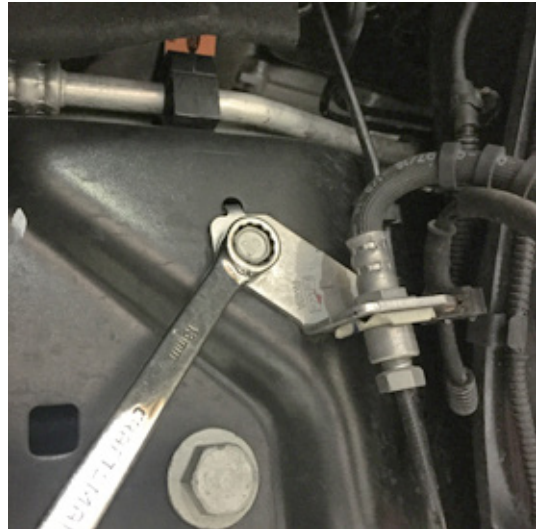

Illustration 7



Illustration 8



10) SHOCK ABSORBERS...

- [Illustration 9] Remove the lower bolt retaining the shock absorber to the axle. Disconnect the shock from the axle. {18mm}

- [Illustration 10] Remove the nut retaining the shock to the upper shock mount. {21mm}

11) COIL SPRINGS...

- Carefully lower the front axle enough to facilitate the removal of the front coil springs. Make sure no hoses or lines are in a bind when lowering the axle.

Illustration 9**Illustration 10****12) TRACK BAR BRACKET...**

- [Illustration 11 & 12] Unbolt the factory track bar bracket from the frame and the crossmember. {frame 18mm, crossmember 21mm}

Illustration 11**Illustration 12****13) PITMAN ARM...**

- [Illustration 13 & 14] Note the orientation of the pitman arm. Remove the nut from the pitman arm and using the appropriate puller tool remove the pitman arm from the sector shaft. {46mm}

Illustration 13**Illustration 14**

FRONT ASSEMBLY

14) PITMAN ARM...

- Install the new pitman arm (01-1116) onto the sector shaft in the same orientation as the factory arm and secure using the supplied 30mm nut. DO NOT REUSE THE FACTORY NUT. (350) {46mm}

15) TRACK BAR BRACKET...

- Position the new track bar bracket (55-03-9066) on the frame in the factory position and secure using the factory hardware. Once all bolts and nuts have been started, tighten. (136) {frame 18mm, crossmember 21mm}

NOTE: Perform the following steps one side at a time. Start on the driver's side.

STANDARD KIT INSTRUCTIONS - If a Radius Arm Kit or 4-Link Kit were purchased, skip to the appropriate installation section.

16) RADIUS ARMS...

- [Illustration 15] Unbolt the radius arm from the frame. {bolt 24mm, nut 27mm}

17) RADIUS ARM BRACKETS...

- [Illustration 16] Position the radius arm bracket (55-05-9090) inside the factory mount and secure using the supplied 18mm x 130mm bolt, nyloc nut, and washer through the rearward most hole. Insert the supplied 18mm x 130mm bolt through the forward most hole and secure with the nyloc nut, and washer. (230) {27mm}

18) RADIUS ARMS...

- The new radius arm bracket used for 4" and 6" kits and has two hole for the radius arm to bolt to. The top hole is for 4" kits and the bottom hole is for 6" kits. Reattach the factory radius arm to the drop bracket and loosely secure using the factory hardware. Do not tighten at this time. {bolt 24mm, nut 27mm}

- Move to Step 19.

Illustration 15**Illustration 16**

RADIUS ARM KIT INSTRUCTIONS - If a Standard Kit or 4-Link Kit were purchased, skip to the appropriate installation section.

16) FACTORY RADIUS ARMS...

[Illustration 17] Unbolt the radius arm from the frame and the axle, then remove. {frame bolt 24mm, nut 27mm; axle 24mm}

17) SUPERLIFT RADIUS ARMS...

[Illustration 18] Attach the new radius arm (55-09-9000 driver's side; 55-10-9000 passenger's side) to the axle using the supplied 18mm x 130mm bolt at the top and the 18mm cam bolt (55-11-9000) and washer (55-21-9910) at the lower mount; loosely secure with the supplied nyloc nuts. Do not tighten at this time. {27mm}

Attach the new radius arm to the factory frame mount and loosely secure using the factory 18mm hardware. {bolt 24mm, nut 27mm}

Move to Step 19.

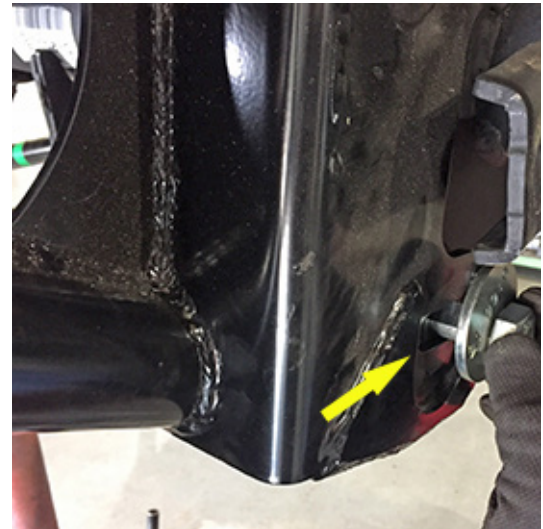
Illustration 17**Illustration 18**

4-LINK KIT INSTRUCTIONS - If a Standard Kit or Radius Arm Kit were purchased, skip to the appropriate installation section.

16) FACTORY RADIUS ARMS...

[Illustration 19] Unbolt the radius arm from the frame and the axle, then remove. {frame bolt 24mm, nut 27mm; axle 24mm}

17) 4-LINK FRAME BRACKETS...

[Illustration 20] Position the radius arm bracket (55-25-9090) inside the factory mount and secure using the supplied 18mm x 130mm bolt, nyloc nut, and washer through the rearward most hole. {27mm}

18) 4-LINK ARMS...

[Illustration 21] Install the new upper four link arm (55-07-9090) on the axle mount and loosely secure using the factory hardware. {24mm}

[Illustration 22] Install the new lower four link arm (55-08-9090) on the axle mount and loosely secure using the supplied 18mm x 130mm cam bolt (55-11-9000) and washers (55-21-9910). {27mm}

[Illustration 20] Attach the upper four link arm to the frame bracket using the supplied 18mm x 130mm bolt, washer, and stover nut. Do not tighten at this time. {27mm}

[Illustration 20] Attach the lower four link arm to the frame bracket using the supplied 18mm x 120mm bolt, washer, and stover nut. Do not tighten at this time. {27mm}

Move to Step 19.

Illustration 21



Illustration 19



Illustration 20



Illustration 22



COIL SPRING KIT INSTRUCTIONS - If a coilover kit was purchased, skip to the installation section below.

19) COIL SPRINGS... If a coilover kit was purchased, skip to the Coilover Kit instructions.

With the coil spring isolator in place on the new coil spring (01-296), install the coil springs over the coil spring upper mount and onto the lower seat. Rotate coil spring until the coil is seated properly against the coil spring stop on the lower seat.

Raise the axle until the coil spring isolator is seated securely against the upper coil tower.

20) SHOCK ABSORBERS...

Install the one of the new supplied shock stem washers and bushings onto the stem of the new shock (Superide 01-88510). Insert the shock stem into the factory upper shock mount and place the second bushing then washer onto the shock stem and secure using the supplied nut. Tighten until the bushing slightly swell.

Move to Step 22.

COILOVER KIT INSTRUCTIONS - If a coil spring kit was purchased, skip to Step 22.

19) COIL SPRING AXLE SEATS...

[Illustration 23] Unbolt the lower coil mount from the axle and discard. {18mm}

20) COILOVER AXLE MOUNT...

[Illustration 24] Make sure the coil spring axle seat is free from any dirt or debris. Mount the lower coilover bracket on the axle using the supplied hardware. (90)

21) COILOVER FRAME MOUNT..

[Illustration 25] Place the reservoir mount, located in the SL5164 box, over the upper factory coil locating boss. Carefully mark the three hole locations. Remove the bracket and drill 7/16" holes in the three marked locations. **WARNING: Take extreme caution to not drill into anything located on top of the coil towers.**

Illustration 23



Illustration 25



Illustration 24



[Illustration 26] Cut the coil spring locating boss flush with the upper coil mount. Grind any remaining edges of the coil spring locating boss so there is a smooth mounting surface.

Place the coilover into the lower mount and secure using the supplied hardware. (90)

Insert the supplied 3/8" bolts into the holes in the coil tower. Note that the short (3/8" x 3/4") bolt goes in the outermost hole. Failure to have the bolts in the correct orientation can cause damage to the hose fitting on the coilover.

Illustration 26



Illustration 27



[Illustration 27] Position the reservoir mount between the shock mount and the frame. Move the coilover into position and tighten the top mounting bolts. (45) Accessing these bolts through the engine compartment may be necessary.

[Illustration 28] Center the reservoir in the mount and secure with the band clamps. Position the reservoir so hose is close to the inside of the wheel well and tighten.

[Illustration 30] Bolt the ABS line and the brake lines to the lower mount, making sure there is adequate clearance to any moving parts.

Move to Step 22.

Illustration 28



Illustration 29



Illustration 30

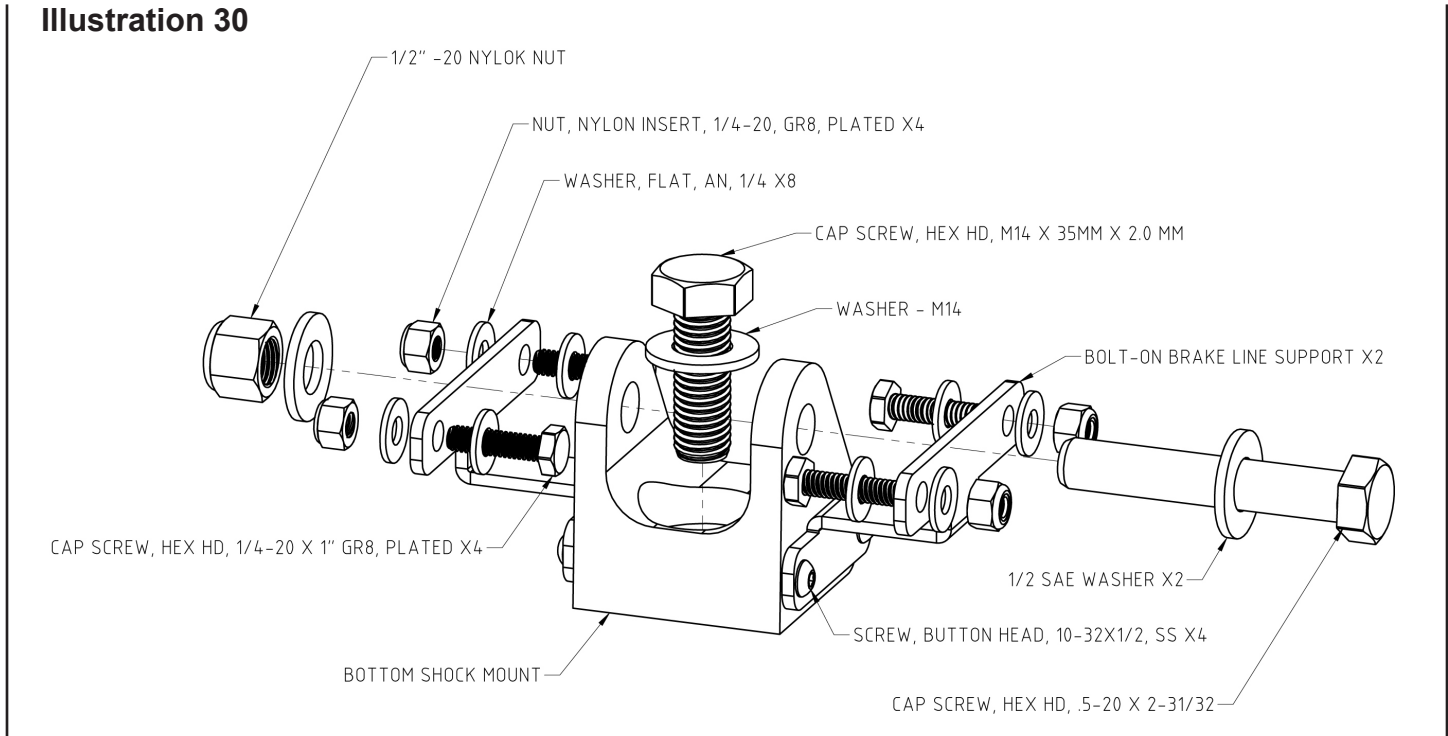

22) BRAKE LINE FRAME BRACKETS...

□□ [Illustration 31 (driver) & 32 (passenger)] Install the new supplied brake line bracket (55-22-9090) to the frame using the factory hardware in the factory location. (18) {13mm}

□□ Install the supplied 1/4" x 1/2" self-tapping bolt into the top hole of the new brake line bracket. This bolt will not "thread" into the frame, rather it will act as a 'pin' to keep the bracket from spinning on the frame.

□□ [Illustration 31 (driver) & 32 (passenger)] Very carefully bend the brake lines so they can be attached to the new brake line bracket. DO NOT OVER BEND or KINK THE LINES. Attach the factory brake line bracket to the new frame bracket using the supplied 3/8" x 1" bolt, washer, and nyloc nut. (30) (9/16")

Illustration 31



Illustration 32



23) DRIVE SHAFT...

- Realign the previously made mark on the drive shaft and install using the factory hardware. Apply thread locker to the bolts before installing. (11) {8mm}

24) ABS and VENT ROUTING...

- [Illustration 31] Disconnect the axle vent line from the frame, located on the driver's side frame rail under the engine mount. {plastic fastener removal tool}
- [Illustration 32] Disconnect the ABS line from the frame, located on the driver's side frame rail under the engine mount just above where the axle vent hose was attached. {plastic fastener removal tool}
- [Illustration 33 & 34] Reattach the ABS line to the frame in the axle vent line's factory location. Reattach the ABS line to the factory location on the radius arm.
- Reconnect the differential vent tube to the axle.

Illustration 33**Illustration 34****Illustration 35****Illustration 36**

25) BUMP STOP BRACKETS...

[Illustration 37] Place the new bump stop front bracket (55-09-9090 driver's side; 55-23-9090 passenger's side) on the factory bump stop pad and with the brake line bracket in place and the tabs hooked on the factory pad, secure it to the lower coil seat using the supplied 8mm x 25mm and washer. (20) {13mm}

[Illustration 38] Install the new bump stop rear bracket (55-10-9090 driver's side; 55-24-9090 passenger's side) on the factory bump stop pad and with the tabs hooked on the factory pad, secure it to the front bracket using the supplied 3/8" x 1" carriage bolt and nyloc nut. Insert bolt from front pointing rearward. (30) {9/16"}

Illustration 37**Illustration 38****26) TIRES / WHEELS...**

Tighten the lug nuts in the sequence shown. (151) {21mm}

WARNING: When the tires / wheels are installed, always check for and remove any corrosion, dirt, or foreign material on the wheel mounting surface, or anything that contacts the wheel mounting surface (hub, rotor, etc.). Installing wheels without the proper metal-to-metal contact at the wheel mounting surfaces can cause the lug nuts to loosen and the wheel to come off while the vehicle is in motion.

WARNING: Retighten lug nuts at 500 miles after any wheel change, or anytime the lug nuts are loosened. Failure to do so could cause wheels to come off while vehicle is in motion.

Lower the vehicle to the floor.

27) TRACK BAR...

[Illustration 39] Observe the two supplied track bar keys and note that the hole in each key is offset to one side. Position the keys so that the holes are offset to the driver's side and insert them into the slotted holes of the track bar bracket. Insert the factory track bar bolt through the bracket, keys, and track bar and secure using the factory hardware. Tighten (406) {30mm}

IMPORTANT: Yes, the proper torque specification for the



track bar eye bolt is 406 lb-ft; this is not a typographical error. If the appropriate torque wrench is not available, tighten the bolt as much as possible, then take the vehicle to the Ford Dealer or a heavy equipment repair shop to perform the final torque operation. Proper torque on this bolt is critical.

28) SWAY BAR...

[Illustration 40] Remove the sway bar body from the frame. {15mm}

[Illustration 41] Install the new sway bar bracket (55-03-9074 driver's side; 55-04-9074 passenger's side) on the frame using the factory nuts. (40) {15mm}.

Illustration 40



Reattach the sway bar body to the new bracket using the supplied 7/16" x 1-1/2" bolts, washers and nyloc nuts. (50) {5/8"}

[Illustration 42] Reattach the sway bar links to the factory mounting hole on the axle using the factory hardware. (100) {18mm}

29) DRAG LINK...

Loosen the drag link adjuster and rotate the drag link 180° to connect the drag link to the pitman arm using the factory castle nut and cotter pin. {24mm, pliers}

30) STEERING STABILIZER BRACKET...

[Illustration 43] Install the new steering stabilizer frame bracket (55-18-9090) using the factory hardware. (37) {15mm}

[Illustration 44] Install the new steering stabilizer drag link bracket (55-19-9090) on the drag link with the clevis pointing to the front and the tab pointing up. Fasten it to the drag link using the supplied 9/16" x 2-1/4" bolt and nyloc nut. (105) {13/16}

[Illustration 44] Attach the steering stabilizer stud to the frame bracket using the factory nut. (50) {15mm}

Illustration 41



Illustration 42

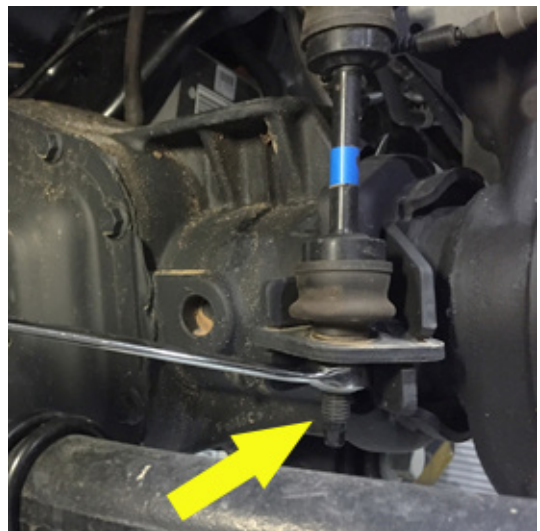

- [Illustration 44] Attach the steering stabilizer eye to the drag link using the supplied 7/16" x 2-1/2" bolt and nyloc nut. (50) {5/8}

Illustration 43**Illustration 44****31) HARDWARE TIGHTENING SEQUENCE...**

- Tighten the following hardware:

Standard Kit

- shock absorber to axle (105) {18mm}
- radius arm to frame (222) {bolt 24mm, nut 27mm}

Radius Arm Kit

- shock absorber to axle (105) {18mm}
- radius arm to axle (222) {upper 24mm, lower 27mm}
- radius arm to frame (222) {bolt 24mm, nut 27mm}

4-Link Kit

- shock absorber to axle (105) {18mm}
- 4-link arms to axle (222) {upper 24mm, lower 27mm}
- 4-link arms to frame (222) {bolt 24mm, nut 27mm}

REAR DISASSEMBLY**30) RAISE REAR OF VEHICLE...**

- Chock the front tires. Position a jack beneath the center of the rear axle then raise rear of vehicle. Secure jack stands beneath the frame rails just forward of the rear springs. Remove rear tires.

31) SHOCK ABSORBERS...

- [Illustration 45] Unbolt the shock absorber from the lower mount. {bolt 18mm, nut 21mm}

Illustration 45

- Unbolt the shock absorber from the upper mount and remove from vehicle. Discard. {18mm}

32) BRAKE LINE BRACKET...

- [Illustration 46 & 47] Remove the rear axle vent hose from the barbed fitting. Remove the barbed fitting and allow the brake line bracket to move freely from the axle. {plastic fastener removal tool, 16mm}

Illustration 46

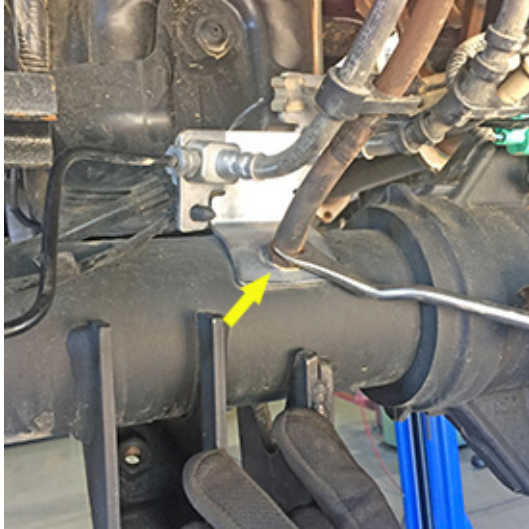

Illustration 47



33) UBOLTS AND BLOCKS...

- [Illustration 48] Using a floor jack support the rear axle and remove the u-bolts and discard. {24mm}
- Lower the axle to remove the factory block. Make sure no brake or ABS lines are in a bind as you lower the axle.

Illustration 48



REAR ASSEMBLY

34) LIFT BLOCKS AND UBOLTS...

- [Illustration 49] Install the new lift blocks (55-01-200). There is an indicator notch in the block that should face the front of the vehicle with the taller end of the block facing the rear. Make sure the locating pins are seated correctly. Jack the axle back into position while making sure that the axle pins are seated correctly into the block.
- [Illustration 50] Install the new block shim (55-03-200) between the block and leaf spring, then place the supplied 7/16" u-bolts over the leaf spring and through the shim and block. Do not tighten at this time.
- [Illustration 51] Install the new u-bolts (11722) using the supplied 5/8" washers and nuts; tighten using the "X" pattern. (210) {7/8"}

Illustration 49**Illustration 50**

- [Illustration 50] Install the supplied 7/16" flange nuts onto the 7/16" ubolts and tighten. (60) {5/8"}

35) SHOCK ABSORBERS...

- Install the supplied 5/8" ID bushing into the eye of the shaft (upper) end and the 3/4" ID bushing into the eye of the body (lower) end. Insert the supplied sleeve into the eye ring on the body (lower) end and install onto vehicle using the factory bolts and nuts. NOTE: KING shocks are pre-assembled and ready to install. They are installed with the body up (frame) and shaft down (axle) (136) {bolt 18mm, nut 21mm}

36) BRAKE LINE BRACKET...

- [Illustration 51] Install the new supplied brake line bracket (55-09-9074) onto the axle between the axle and the factory brake line bracket. Do not kink the brake lines. Secure using the barbed fitting. {16mm}

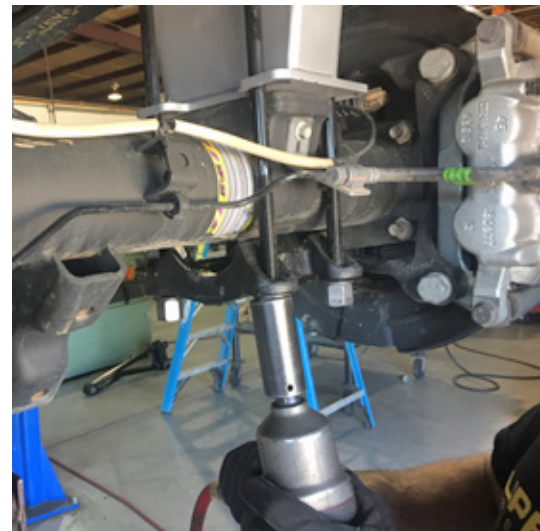

37) AXLE VENT HOSE...

- [Illustration 52] Attach the vent hose to the barbed fitting.

38) TIRES / WHEELS...

- Reinstall tires and wheels. Tighten the lug nuts in the sequence shown. (151) {21mm}

WARNING: When the tires / wheels are installed, always check for and remove any corrosion, dirt, or foreign material on the wheel mounting surface, or anything that contacts the wheel mounting surface (hub, rotor, etc.). Installing wheels without the proper metal-to-metal contact at the wheel mounting surfaces can cause the lug nuts to loosen and the wheel to come off while the vehicle is in

Illustration 52

motion.

WARNING: Retighten lug nuts at 500 miles after any wheel change, or anytime the lug nuts are loosened. Failure to do so could cause wheels to come off while vehicle is in motion.

Lower vehicle to the floor.

39) CLEARANCE CHECK...

With the vehicle on the ground, check all components for proper operation and clearances. Pay special attention to the clearance between the tires / wheels, brake hoses, wiring, etc.

40) FOUR WHEEL DRIVE...

Activate four wheel drive system and check for proper engagement.

41) ALIGNMENT...

A front end alignment is necessary after the installation of the radius arm and 4 link kits.

42) HEADLIGHTS...

Re-adjust headlights to proper setting.

43) SUPERLIFT WARNING DECAL...

Install the WARNING TO DRIVER decal on the inside of the windshield, or on the dash, within driver's view. Refer to the "NOTICE TO DEALER AND VEHICLE OWNER" section below.

44) SUPERLIFT BADGES...

This kit is packaged with a Superlift badge. Prior to installation, use the supplied alcohol pad to eliminate all soap and or other non-adhering residues that may impair adhesion, thoroughly clean the entire area of placement.

The adhesive on our badges is pressure sensitive and must be applied using pressure on all areas of the graphic. Like any PSA (pressure sensitive adhesive), it can take up to 72 hours for the adhesive to fully cure. Once the badge is in place do not peel it up, this will diminish the adhesive properties and could result in damaging the badge itself.

To keep your Superlift badge in "like new" appearance keep the badge free/clear of solvents and chemicals that could cause the adhesive to dry or dissolve. This includes gasoline, diesel fuel, paint thinner, and alcohol. Soap and water is all that is needed for cleaning. Degreasers can be used sparingly and hand whipped/applied if needed, although not suggested.

Important Maintenance Information

It is the ultimate buyer's responsibility to have all bolts / nuts checked for tightness after the first 100 miles and then every 1000 miles. The steering, suspension and driveline systems, plus wheel alignment should be inspected by a qualified professional mechanic at least every 3000 miles.

Limited Lifetime Warranty / Warnings

Your Superlift® product is covered by the Limited Warranty explained below that gives you specific legal rights. This limited warranty is the only warranty Superlift® makes in connection with your product purchase. Super-

lift® neither assumes nor authorizes any retailer or other person or entity to assume for it any other obligation or liability in connection with this product or limited warranty.

Superlift, LLC, Limited Lifetime Warranty

What is covered? Subject to the terms below, Superlift® will repair or replace its products found defective in materials or workmanship for so long as the original purchaser owns the vehicle on which the product was originally installed. Your warrantor is Superlift, LLC, doing business as Superlift® Suspension Systems (“Superlift®”).

What is not covered? Your Superlift® Limited Warranty does not cover products Superlift® determines to have been damaged by or subjected to:

- Alteration, modification or failure to maintain.
- Normal wear and tear (bushings, rod ends, etc.). Scratches or defects in product finishes (powder coating, plating, etc.).
- Damage to, or resulting from, the vehicle’s electronic stability system, related components or other vehicle systems.
- Racing or other vehicle competitions or contests. Accidents, impact by rocks, trees, obstacles or other aspects of the environment.
- Theft, vandalism or other intentional damage.

Remedy Limited to Repair or Replacement. The exclusive remedy provided hereunder shall, upon Superlift’s inspection and at Superlift’s option, be either repair or replacement of the product covered under this Limited Warranty. Customers requesting warranty consideration should contact Superlift® by phone (1-800-551-4955) to obtain a Returned Goods Authorization number. All removal, shipping and installation costs are customer’s responsibility.

If a replacement part is needed before the Superlift® part in question can be returned, you must first purchase the replacement part. Then, if the part in question is deemed warrantable, you will be credited / refunded.

Other Limitations - Exclusion of Damages - Your Rights Under State Law

- Neither Superlift® nor your independent Superlift® dealer are responsible for any time loss, rental costs, or for any incidental, consequential or other damages you may have.
- This Limited Warranty gives you specific rights, and this is the only warranty Superlift® makes in connection with your product purchase. You may also have other rights that vary from state to state. For example, while all implied warranties are disclaimed herein, any implied warranty required by law is limited to the terms of our Limited Lifetime Warranty as described above. Some states do not allow limitations of how long an implied warranty lasts and / or do not allow the exclusion or limitation of incidental or consequential damages, so the limitations and exclusions herein may not apply to you. Superlift® neither assumes nor authorizes any retailer or other person or entity to assume for it any other obligation or liability in connection with this product or Limited Warranty.

Superlift, LLC, Satisfaction Guarantee

We want you to purchase our product with confidence and be 100% satisfied with the end result. If you have any legitimate issue, and Superlift® cannot rectify it to your satisfaction, Superlift® will take back the Superlift® brand product and refund the customer 100% of the product purchase price.

The details:

- Offer valid to the original retail consumer for six months after product purchase.
- May require a Superlift® dealer's participation in order to assist in "troubleshooting" the issue.
- Any costs related to labor, freight, incidental or consequential are not refunded.
- Refund will not exceed Superlift's® published retail price.

Important Product Use and Safety Information / Warnings

As a general rule, the taller a vehicle is, the easier it will roll over. Offset, as much as possible, what is lost in rollover resistance by increasing tire track width. In other words, go "wide" as you go "tall"; always use as wide a tire and wheel combination as feasible to enhance vehicle stability. We strongly recommend, because of rollover possibility, that the vehicle be equipped with a functional roll bar and cage system. Seat belts and shoulder harnesses should be worn at all times. Avoid situations where a side rollover may occur.

Generally, braking performance and capabilities are decreased when significantly larger / heavier tires and wheels are used. Take this into consideration while driving. Also, changing axle gear ratios or using tires that are taller or shorter than factory height will cause an erroneous speedometer reading. On vehicles equipped with an electronic speedometer, the speed signal impacts other important functions as well. Speedometer recalibration for both mechanical and electronic types is highly recommended.

Do not add, alter, or fabricate any factory or aftermarket parts to increase vehicle height over the intended height of the Superlift® product purchased. Mixing component brands is not recommended.

SUPERLIFT SUSPENSION

300 Huey Lenard Loop Rd.
West Monroe, Louisiana 71292
Phone: (318) 397-3000
Sales / Tech: (800) 551-4955
Fax: (318) 397-3040
www.superlift.com