

# **ARB** FITTING INSTRUCTIONS

## **ARB PRADO BULL BAR TO SUIT GX, GXL, VX AND GRANDE 2003 ONWARDS.**

- **PART No 3221400 TO SUIT PRADO GX**
- **PART No 3221410 TO SUIT GXL, VX AND GRANDE**
- **Fitting Kit No's: 6172340 (3221400) 6172341 (3221410)**

### **WARNING**

**FOR VEHICLES EQUIPPED WITH SRS AIRBAG**  
**WHEN INSTALLED IN ACCORDANCE WITH THESE INSTRUCTIONS, THE FRONT PROTECTION BAR DOES NOT AFFECT OPERATION OF THE SRS AIRBAG.**

#### **TAKE NOTE OF THE FOLLOWING:**

- **THIS PRODUCT MUST BE INSTALLED EXACTLY AS PER THESE INSTRUCTIONS USING ONLY THE HARDWARE SUPPLIED.**
- **IN THE EVENT OF DAMAGE TO ANY BULL BAR COMPONENT, CONTACT YOUR NEAREST AUTHORISED ARB STOCKIST. REPAIRS OR MODIFICATIONS TO THE IMPACT ABSORPTION SYSTEM MUST NOT BE ATTEMPTED.**
- **DO NOT USE THIS PRODUCT FOR ANY VEHICLE MAKE OR MODEL, OTHER THAN THOSE SPECIFIED BY ARB.**
- **DO NOT REMOVE LABELS FROM THIS BULL BAR.**
- **THIS PRODUCT OR ITS FIXING MUST NOT BE MODIFIED IN ANY WAY.**

#### **OPTIONAL LIGHT SETS TO SUIT THIS PRODUCT:**

- **ARB 6821201 Fog Light Kit Suit 3163015**
- **Up to IPF 900 SERIES FOG OR DRIVING LIGHT SETS**

**Tools Required For Bar Fitment: Basic Tool Kit, 17mm Tube Spanner, Cir-Clip pliers, Drill, 10mm and 13mm Drill Bits.**

Note: Parts In *Italics*, only one supplied with kit depending on model of vehicle.

USE.	PART NO.	QTY	DESCRIPTION
<b>Impact Absorber To Chassis</b>	3757757	1	Bracket Mount Assembly
	3756645R	1	Bracket Mount Brace RHS
	3756645L	1	Bracket Mount Brace LHS
	3193741	2	Captive Nut Plate
	6151306	2	Nut Cage M12 x 1.75
	6151255	8	Bolt M12 x 1.75 x 40mm
	6151189	6	Nut M12 x 1.75
	6151094	2	Bolt M12 x 1.25 x 30mm
	4581049	18	Washer Flat ½"
	4581050	10	Washer Spring ½"
	5846401	4	Spacer 8mm
<b>Bull Bar To Impact Absorber</b>	6151304	6	Nut Cage M10 x 1.5
	6151232	8	Bolt M10 x 1.5 x 30mm
	4581040	10	Washer Flat M10 x 2mm
	4581048	8	Washer Spring M10
	6151026	2	Nut M10 x 1.5
<b>Stone Tray to Bull Bar</b>	6542051	1	Stone Tray
	6151300	4	Nut Cage 6mm
	6151017	4	Bolt M6 x 16mm
	4581072	4	Washer Flat M6
	4581036	4	Washer Spring M6
<b>Buffers To Bull Bar</b>	3162470R	1	Buffer Standard RHS
	3162470L	1	Buffer Standard LHS
	6151128	12	Nut Flange M6
<b>Indicators To Bull Bar</b>	3163015	1	Combination Light Surround Kit
	6821152	2	Turn signal / clearance light loom
	6821151L	1	Turn Signal / Clearance Light
	6821151R	1	Turn Signal / Clearance Light
	180701	6	Scotch Lock
<b>Licence Plate To Bull Bar</b>	6151128	2	Nut Flange M6
	6781408	1	Tape Double sided
<b>Miscellaneous</b>	6821132	2	Rubber Grommet 3/8" ID
	180302	6	Cable Ties
	3162152	2	Plastic Plug 16mm DIA
<b>Washer Bottle Guard To Bull Bar</b>	<i>6522028L</i>	<i>1</i>	<i>Washer Bottle Guard For 3221410</i>
	<i>6522028R</i>	<i>1</i>	<i>Washer Bottle Guard For 3221410</i>
	<i>6522029L</i>	<i>1</i>	<i>Washer Bottle Guard For 3221400</i>
	<i>6522029R</i>	<i>1</i>	<i>Washer Bottle Guard For 3221400</i>
	6151234	10	Bolt M8 x 25mm Black
	4581045	10	Washer Flat M8 Black
	6151132	10	Nut Flange M8



1. Remove front bumper cover from vehicle.
2. Remove front bumper reinforcing bar.
3. Remove side bumper supports from both guards.

NOTE: Retain the 8 flange nuts removed for fitment of the bull bar chassis mount.



4. Fit cage nuts to the bull bar. M10's to the six square holes in the upright and M6's in the four square holes in the lower part of the pan. Also fit the M12 cage nuts to the captive nut assembly.



5. Using the 13mm drill bit, drill out the M8 captive nut in the top of the chassis on both sides of the vehicle.

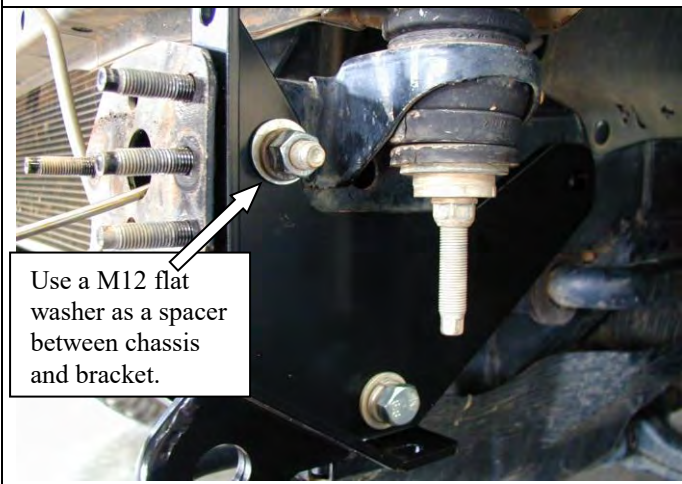

6. Fit the chassis mount braces to the vehicle using the M12 x 30mm fine pitched bolt, M12 spring and flat washers supplied in the lower hole. Use a M12 flat washer as a spacer between the brace and the chassis at the upper hole and fix with a M12 x 40mm bolt M12 spring and flat washers and M12 x 1.75 nut. Do not tighten the bolts.

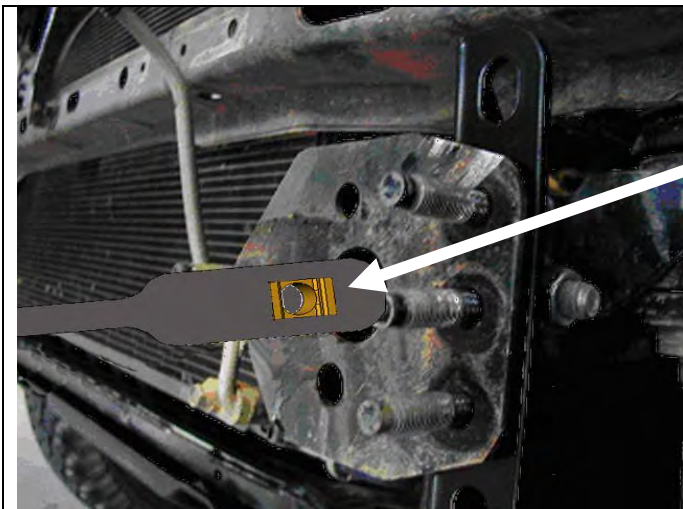

7. Insert the captive nut assembly through the front of the chassis and line it up with the hole at the end of the mount brace. Fix in place with the M12 x 1.75 x 40mm bolt, M12 flat and spring washers. Break off the end of the captive nut plate. Do not tighten yet.

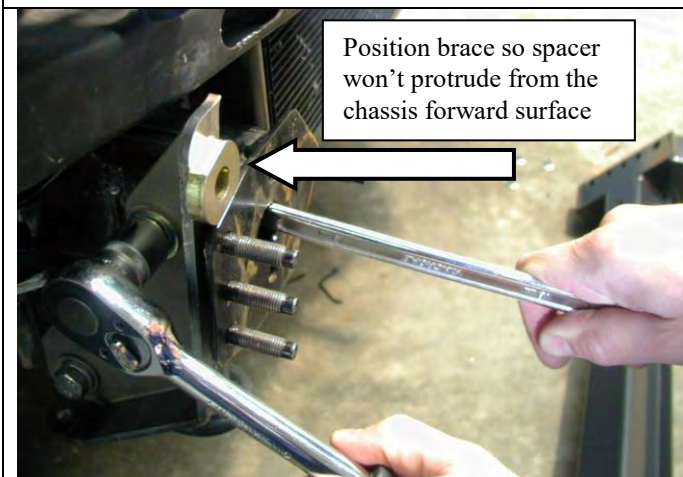

8. Hold the 8mm spacer against the chassis mount brace forward facing surface and position the brace so that the spacers sit just below the surface of the chassis front face. Tighten the bolts.



9. Fit the chassis mount bracket to the chassis using the original flange nuts removed with the bumper reinforcing bar. Centre the chassis mount bracket and tighten.

**CAUTION:** when fitting the Chassis mounting bracket carefully bend the air-conditioning pipe out of the way.

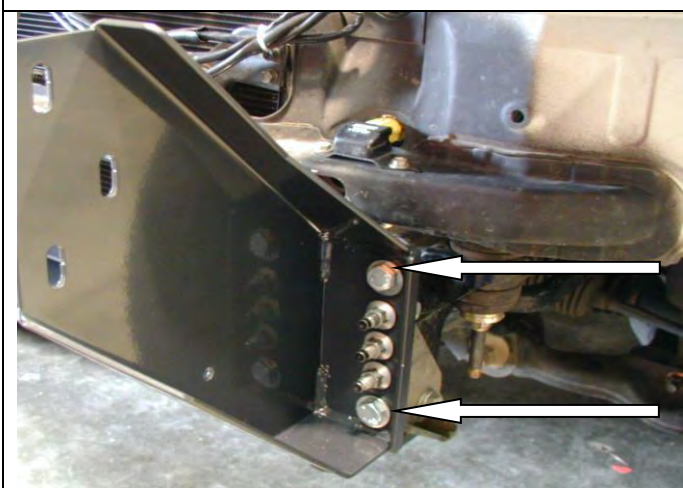

10. Fix the chassis mount bracket to the chassis mount brace using M12 x 40mm bolts, M12 spring and flat washers, the 8mm spacers and M12 x 1.75 nuts. Tighten bolts.



11. Place the double-sided tape along the top edge of the licence plate. Using the original screws and M6 flange nuts supplied in the fitting kit, attach the licence plat to the bull bar.

12. Fit the buffers to either side of the bull bar using 6 M6 flange nuts. **Do not over tighten.**

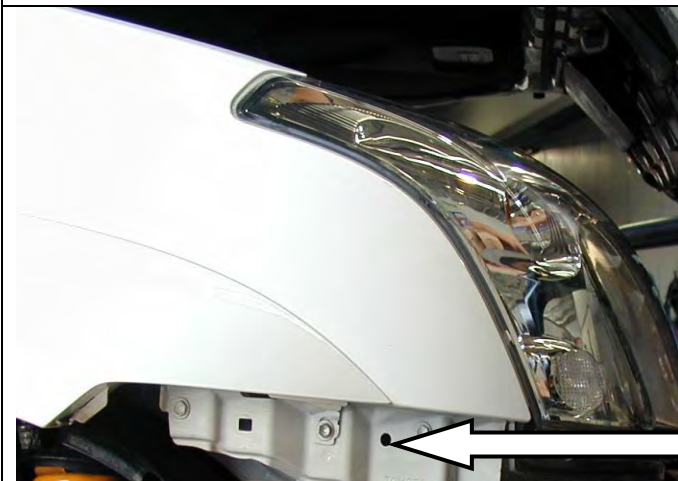

13. Mask the area around the headlight and the front guard and paint the lower section under the front guard black.

Paint this section on both sides black



14. With the help of an assistant position the bull bar on the chassis bracket and fix with six M10 x 30mm bolts, M10 spring and flat washers.

Do not tighten the bolts yet.



15. Position the bull bar so that there is an even gap along the headlights and the guards of **25mm**. tighten all the bolts.

**25mm gap**



16. With the bull bar in position drill a 10mm hole through the upright on both sides using the hole in the chassis bracket as a template.
17. Fix in place using two M10 x 30mm bolts, M10 spring washers, M10 Flat washers and M10 x 1.5 nuts.



18. Remove the front stone tray from the vehicle and remove the tags at the front of the tray. Refit the stone tray fixing in place with the rear bolts only.



19. Fit the bull bar stone tray by sliding the tray under the front of the vehicles original stone tray and fixing in place with the original bolts from the vehicles stone tray.
20. Fit the front of the stone tray to the bull bar with four M6 x 16mm bolts, M6 large panel washers and M6 spring washers.

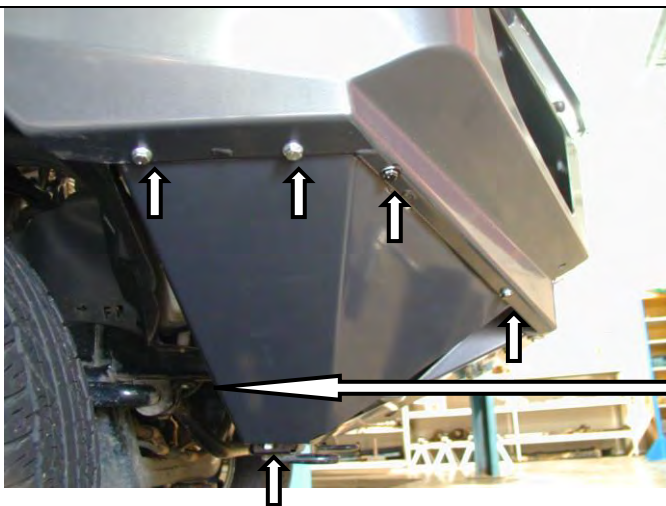

21. Fit the washer bottle guard with five M8 x 25mm black bolts, M8 black flat washers and M8 flange nuts.
22. Repeat for the passenger side.

After fitting the washer bottle guards, trim the inner guard liners so they don't protrude below the line of the washer bottle guard. Fix in place with cable ties.

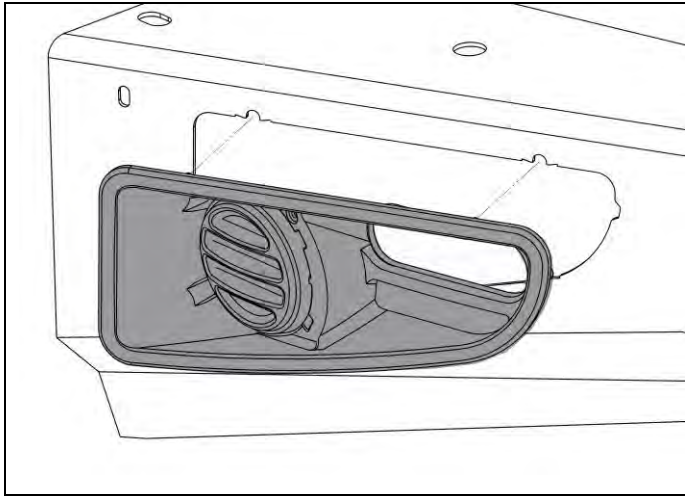

23. Assemble and install combination light surrounds (p/n 3163015) as per instructions no. 3786421 supplied with surround kit. Note: Optional fog lamps can be installed at this point as per fitting instruction no. 3783315 supplied with fog lamp kit no. 6821201. Wire the combination lamp to the vehicles indicator and clearance lamps. Caution: Cable tie all cables together and keep all cables clear of sharp edges and moving parts.

When finished make sure all bolts are tightened and that all wiring is clear of hot, sharp and moving parts.

Also supplied in the kit are two 3/8" rubber grommets and two 16mm plugs. The rubber grommets are for the two holes in the top pan if lights are being fitted. The two plastic plugs are for the holes in the top surface of the wings if no CB aerials are going to be connected.