



# FITTING INSTRUCTIONS

Part Number: **3440530**  
Product Description: **SUMMIT BULL BAR**  
Suited to vehicle/s: **FORD RANGER PX MK2 & EVEREST (NOT TITANIUM)**  
Optional Kits: **3500720** Winch Install Kit  
**3500640** ARB AUX Fog Light Adaptor  
**3500530** ARB AUX Fog Light Loom (2015 ON Wildtrak, Everest & on-factory fog lamp vehicles)  
**3500680** Fog Lamp Housing Clear Lens Kit  
**3500590** Fog Light Kit (LH&RH Lights)  
**3540200** ADAPTIVE CRUISE CONTROL KIT  
**3540190** ADAPTIVE CRUISE CONTROL COVER

**NOTE: ARB recommends purchase of correctly colour coded sensors from a Ford dealer. Painting over sensors is not recommended as sensor operational faults can result.**

## WARNING

### REGARDING VEHICLES EQUIPPED WITH SRS AIRBAG:

When installed in accordance with these instructions, the front protection bar does not affect operation of the SRS airbag.

### ALSO, NOTE THE FOLLOWING:

- ◆ This product must be installed exactly as per these instructions using only the hardware supplied.
- ◆ In the event of damage to any bull bar component, contact your nearest authorised ARB stockist. Repairs or modifications to the impact absorption system must not be attempted.
- ◆ Do not use this product for any vehicle make or model, other than those specified by ARB.
- ◆ Do not remove labels from this bull bar.
- ◆ This product or its fixing must not be modified in any way.
- ◆ The installation of this product may require the use of specialized tools and/or techniques
- ◆ It is recommended that this product is only installed by trained personnel
- ◆ These instructions are correct as at the publication date. ARB Corporation Ltd. cannot be held responsible for the impact of any changes subsequently made by the vehicle manufacturer
- ◆ During installation, it is the duty of the installer to check correct operation/clearances of all components
- ◆ Work safely at all times
- ◆ Unless otherwise instructed, tighten fasteners to specified torque

## **ARB 4x4 ACCESSORIES**

### Corporate Head Office

42-44 Garden St  
Kilsyth, Victoria  
AUSTRALIA 3137

Tel: +61 (3) 9761 6622  
Fax: +61 (3) 9761 6807

Australian enquiries  
North & South American enquiries  
Other international enquiries

sales@arb.com.au  
sales@arbusa.com  
exports@arb.com.au

[www.arb.com.au](http://www.arb.com.au)

# GENERAL CARE AND MAINTENANCE

By choosing an ARB Bar, you have bought a product that is one of the most sought after 4WD products in the world. Your bar is a properly engineered, reliable, quality accessory that represents excellent value. To keep your bar in original condition it is important to care and maintain it following these recommendations:

- Prior to exposure to the weather your bar should be treated to a Carnuba based polish on all exposed surfaces. It is recommended that this is performed on a six monthly basis or following exposure to salt, mud, sand or other contaminants.
- As part of any Pre Trip Preparation, or on an annual basis, it is recommended that a thorough visual inspection of the bar is carried out, making sure that all bolts and other components are torqued to the correct specification. Also check that all wiring sheaths, connectors, and fittings are free of damage. Replace any components as necessary. This service can be performed by your local authorized ARB Stockist

## Important electrical system information

**The 2011-On Ford Ranger uses an advanced wiring system allowing new chassis control systems to be used. Due to this, placing large amounts of additional load to the wiring harness may trigger faults in the ECU or cause permanent damage to the wiring harness.**



**Maintenance of adaptive cruise control components (if fitted, available on 2015 ON Ranger) must only be performed by an authorized ARB workshop. No adjustments to the radar and/or bull bar are permissible following original fitment unless conducted by your local authorized ARB stockist. Regular cleaning of the radar must be carried out in order to ensure optimal operation. Ensure that no foliage, dirt or material is obstructing the radar's field of vision as this may impact the performance of the radar**

## FITTING REQUIREMENTS

### REQUIRED TOOLS FOR FITMENT OF PRODUCT:

BASIC TOOL KIT	ELECTRIC DRILL & Ø2, Ø5.5, Ø7 & Ø10MM BITS
JIG SAW OR MULTI-TOOL WITH BLADE SUITABLE FOR PLASTIC	MATTE BLACK SPRAY PAINT
FILE OR SAND PAPER	MASKING TAPE
BASIC MEASURING TOOLS	ELECTRICAL TAPE (BLACK)
CONVOLUTED TUBE (7MM & 12MM)	HACK SAW OR EQUIV.
TORQUE WRENCH 9-100 Nm CAPACITY	LARGE G-CLAMP
LOCTITE 243	

### HAVE AVAILABLE THESE SAFETY ITEMS WHEN FITTING PRODUCT:

Protective eyewear		Hearing protection	
--------------------	---	--------------------	---

**NOTE: 'WARNING' notes in the fitting procedure relate to OHS situations, where to avoid a potentially hazardous situation it is suggested that protective safety gear be worn or a safe work procedure be employed. If these notes and warnings are not heeded, injury may result.**

### FASTENER TORQUE SETTINGS:

SIZE	Torque (Nm)	Torque (ftlb)
Plastics Screws	0.8	0.6
M6	9	7
M8	22	16
M10	44	32
M12	77	57
M16	90	66

## PARTS LISTING

APPLICATION.	PART NO.	DESCRIPTION	QTY
FIT MOUNT BRACKET TO CHASSIS	3759563	BRACKET CHASSIS MOUNT RANGER LRG RAD	1
	3759574R	BRACKET CHASSIS BRACE INNER RIGHT	1
	3759574L	BRACKET CHASSIS BRACE INNER LEFT	1
	3759575R	BRACKET CHASSIS BRACE OUTER RIGHT	1
	3759575L	BRACKET CHASSIS BRACE OUTER LEFT	1
	3759576R	BRACKET BULL BAR BRACE RIGHT	1
	3759576L	BRACKET BULL BAR BRACE LEFT	1
	4584375	SPACER Ø1 ¼" 15MM THICK	2
	5848427	PACKER CHASSIS 5MM THICK	4
	6151357	BOLT SEMS M10 X 30 ZP Gd 8.8	10
	4581011	WASHER FLAT, M12 x 27 x 4	10
	4581083	WASHER FLAT, M10 x 21 x 2 ZP	2
	4581050	WASHER SPRING 1/2 x 3/16 x 3/16 ZP	10
	4581048	WASHER SPRING M10 TZP480	2
	6151360	BOLT M12 x 1.75 x 35 Gd 8.8 ZP	10
	6151428	NUT FLANGE M12 X 1.75 ZP	10
	6151456	BOLT M10 x 1.5 x 45 Gd 8.8 ZP	2
	6151727	BOLT HXFL M16 x 2.0 x 35 FT PC8.8 TZP	2
	6151728	NUT FL SM M16 x 2.0 PC8 TZP	2
FIT BAR TO MOUNT BRACKET	4584376	SPACER Ø1 ¼" 35MM THICK	2
	6151357	BOLT SEMS M10 X 30 ZP Gd 8.8	4
	6151306	NUT CAGED M12 1.8-3.2	6
	4581050	WASHER SPRING 1/2 x 3/16 x 3/16 ZP	6
	6151360	BOLT M12 x 1.75 x 35 Gd 8.8 ZP	4
	6151168	BOLT M12 x 1.75 x 80 CL8.8 ZP	2
	3194293	PLATE NUT MOUNT RANGER T6	2
	4581007	WASHER FLAT 1/2 x 1.1/2 x 4MM SILVER	6
	6151321	NUT FLANGE M10 x 1.5 ZP	12
MISC	3789424	CUTTING TEMPLATE BUMPER RANGER 15 ON	1
	6151349	8 - 15 X 15 mm BUTTON HEAD SELF TAPPING GP	4
	180302	CABLE TIE 4.8 X 180 MM BLACK	12
	6191037	PINCH WELD 1000mm	1
FIT LICENSE PLATE BRACKET	6151213	BOLT M6 x 1.0 x 20 Gd8.8 BZ	3
	4581287	WASHER SPRING M6 x 2.5 x 1.6 BLK ZN	3
	4584295	WASHER FLAT M6 X 12 X 1.3 BLK ZN	3
	6151128	NUT FLANGE M6 x 1.0 ZP	3
	3759488	BRACKET LIC PLATE FIXED LARGE RAD	1
	6821189	GROMMET RND FC 1500 080 090	2
	6151384	SCREW 10G x 5/8 SELF TAPPING	2
FIT WINCH ACCESS PANEL	6151213	BOLT M6 x 1.0 x 20 Gd8.8 BZ	4
	4581287	WASHER SPRING M6 x 2.5 x 1.6 BLK ZN	4
	4584295	WASHER FLAT M6 X 12 X 1.3 BLK ZN	4
	6151128	NUT FLANGE M6 x 1.0 ZP	4
	6522985	PRESS FORM WINCH COVER PANEL	1

## PARTS LISTING

APPLICATION.	PART NO.	DESCRIPTION	QTY
FIT UNDER PANELS	6522940R	PANEL UNDER WING RANGER 11ON LRG RAD	1
	6522940L	PANEL UNDER WING RANGER 11ON LRG RAD	1
	3758957	BRACKET WING PANEL RANGER T6	2
	6151132	NUT FLANGE M8 x 1.25 ZP	7
	4581082	WASHER FLAT, M6 x 19 x 1.6 BZ	10
	4581047	WASHER SPRING M8 x 3/32 x 3/33 BLK	14
	4581287	WASHER SPRING M6 x 2.5 x 1.6 BLK ZN	10
	6151234	BOLT M8 x 1.25 x 25 Gd 8.8 BP	14
	6151213	BOLT M6 x 1.0 x 20 Gd8.8 BZ	10
	6151300	NUT CAGED M6 2.6-3.5	10
	6151301	NUT CAGED M8 3.3-4.7	7
	6522838	PANEL SPLASH RANGER T6	1
	3758956	BRACKET OE STONE SHEILD RANGER T6	1
	6151357	BOLT SEMS M10 X 30 ZP Gd 8.8	2
	6151321	NUT FLANGE M10 x 1.5 ZP	2
	4581307	WASHER FLAT, M8 x 20 x 2 BLK ZN	14
	LIGHTS AND MOULDINGS	6821287	LAMP LED INDICATOR CLEARANCE
3163082		KIT SURROUND ARB FOGLIGHT	1
6821116		GROMMET NYLON SNAP IN TYPE	4
3500880		GRILLE SPLIT PAN KIT	1
5100200		BUFF KIT 2PCE FRONT SECTION	1
5100210		BUFF KIT 2PCE REAR UPRIGHT BAR	1
DIGITAL RADIO ANTENNA RELOCATION	6151464	SCREW BUTTON HEAD M8 x 1.25 x 25 BLK ZN	2
	4581047	SPRING WASHER M8 BLK ZN	2
	4581307	WASHER FLAT M8 BLK ZN	2
	6151548	NUT FLANGE M8 x 1.25	2
PARKING SENSORS	3500960	SENSOR SURROUND KIT	1

## FITTING PROCEDURE

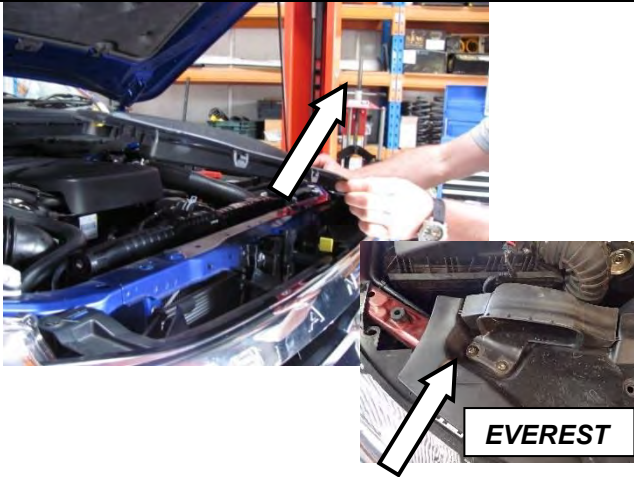

**Note: Read the instructions thoroughly before starting.**

1. Open the bonnet and remove the screws and retaining clips used to retain the plastic cover above the grille.

Carefully detach plastic cover.

**Note: Everest requires the 2 bolt securing air duct to be removed.**

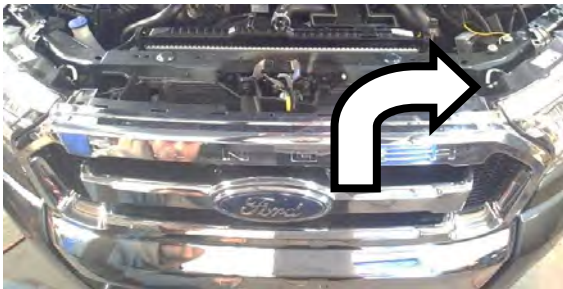

FOR RANGER:

2. Remove the screws and retaining clips used to retain grille.

Carefully detach grille piece from vehicle.

FOR EVEREST:

3. Remove 2 screws retaining grille.

Retain screws and clips.

**Note: Take note where fasteners are removed from as some have to be replaced later in the fitment.**



4. Remove all the bumper fasteners along the inside edge of the wheel arches.



FOR RANGER:

5. Remove all the fasteners securing the bottom of the bumper to the vehicle.

## FITTING PROCEDURE

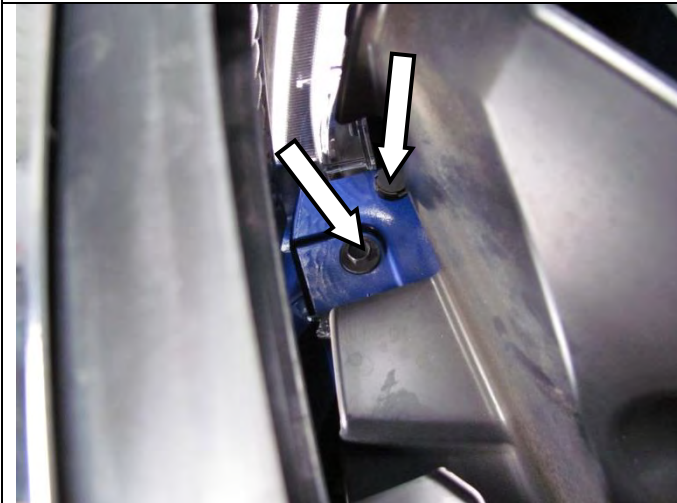

FOR RANGER:

6. Undo and remove the screws and plastic clips behind the grille near the lower inner edge of the head lights.

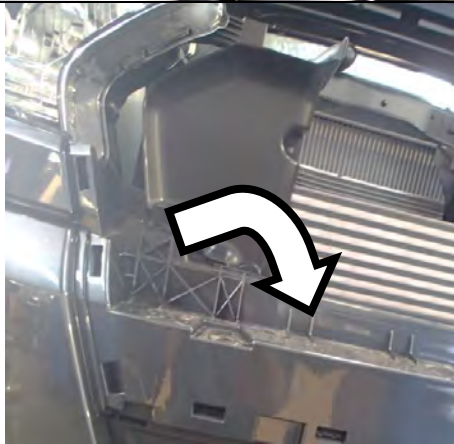

FOR RANGER:

7. Remove the screws and clips holding the inner grille air deflector to the vehicle.
8. Retain air deflectors, screws and clips.



FOR RANGER:

9. Carefully remove all clips used to retain bumper to crash beam.

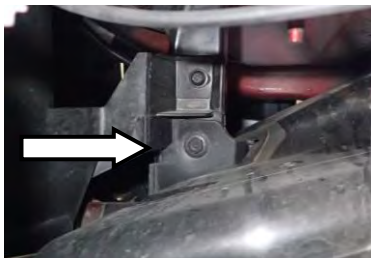

FOR EVEREST:

10. On both sides undo and remove the screws behind the grille near the lower inner edge of the head lights.



FOR EVEREST:

11. Remove all the fasteners securing RH SIDE outer trim panel to the vehicle and detach. Discard the panel.
12. Repeat on LH Side

## FITTING PROCEDURE



### FOR EVEREST:

13. Remove all the fasteners securing centre trim panel to the vehicle and detach. Discard the panel.



14. Disconnect all sensors and fog lights attached to the bumper and allow them to hang loose.

**NOTE: Parking sensor connector is on LH side of bumper.**

15. Starting on the RH side of the vehicle, carefully pull the rear most corner away from the vehicle un-clipping the bumper. With the assistance of another person remove the bumper from the vehicle and place in a safe place where it will not be damaged.

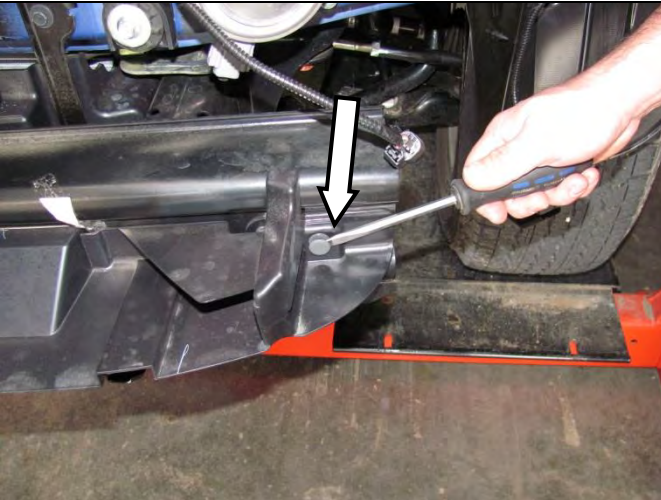

### FOR RANGER:

16. Remove the plastic panel attached to the front cross beam by removing the plastic clips. Discard the panel.



### FOR EVEREST:

17. Remove the foam piece attached to the front cross beam by removing the plastic clips. Discard the foam piece.

## FITTING PROCEDURE

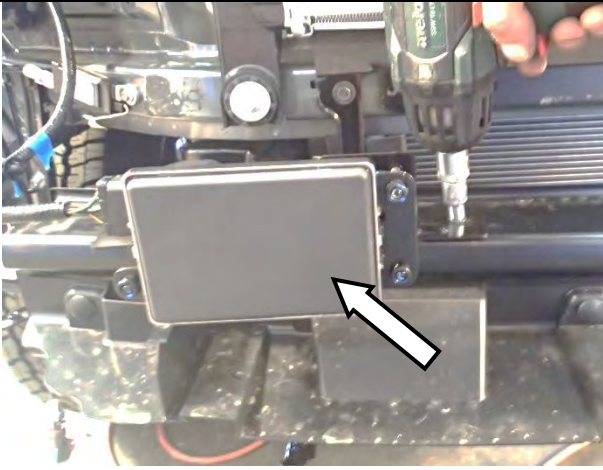

18. If vehicle is fitted with radar, refer to fitting instructions supplied with adaptive cruise control kit (Part No. 3540190 - purchased separately) for removal and relocation.

If not, proceed to step 19.

**NOTE: Radars are initialised to each vehicle and cannot be used on other vehicles.**



19. Use a screw driver to push the 2 x plastic clips inward from the front cross beam. Do not remove the clips as they will be used later.



20. Remove the factory under panel and place in a safe place. **Do not completely remove the rear bolts. Leave loose.**



21. Remove the front cross beam and discard.



## FITTING PROCEDURE



22. Remove screws retaining RH & LH bumper retention blocks to vehicle and remove the retention blocks from both sides and set aside.

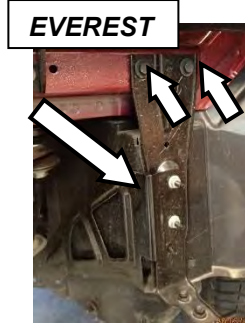
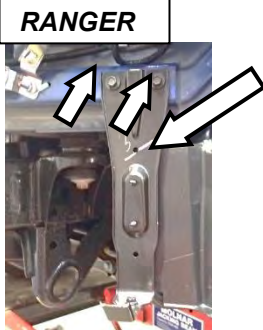

23. Remove and discard the inner guard support brackets from both sides of the vehicle.

24. Following fitting instructions 3789197 supplied in kit 6821287; install the LED combination lamp looms (also supplied in same kit).

**Notes:**

- Use a test light or multimeter to pick the appropriate wire to attach the loom to.
- Cover each joint with either insulation tape or heat shrink tube.
- Use cable ties to secure all wiring

Function	LED Wire	Vehicle Wire	
		RANGER	EVEREST
Ground	Black	BLK/Purple (RHS) BLK/Yellow (LHS)	
Indicator	Green	Blue/Orange (RHS) Green/Blue (LHS)	
Clearance	Red	Brown/Yellow (RHS) Green/Yellow (LHS)	Pink/Yellow (RHS) Green/Orange (LHS)

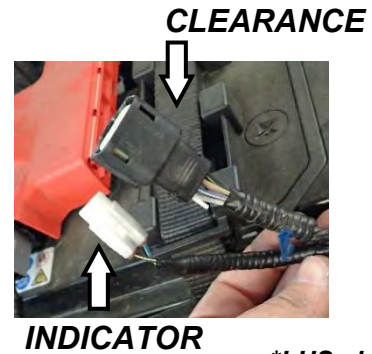

**NOTE:** The wiring in vehicles fitted with factory 35W fog lights (2015 ON Wildtrak Model or Everest) is not suitable for running ARB fog lamps. Proceed to step 28.

**For vehicles without factory fog lamps and where optional ARB fog lamps are to be fitted:**

25. Install optional ARB wiring loom 3500530 and switch into vehicle. Refer to instructions supplied with loom. Place switch inside cabin in a suitable position.
26. Connect optional ARB fog lights (# 3500590) to wiring loom.
27. Proceed to step 34.

**CAUTION:** Ensure that all cables are securely fastened away from sharp, abrasive or hot surfaces.

## FITTING PROCEDURE

**Keep these items**



**Discard these items**



**Black/white trigger wire**

**Cover black wire bullet terminal with tape**



### **For vehicles with factory fog lamps:**

28. The factory fog light switch can be used in conjunction with the ARB loom 3500530 to power the ARB fog lights.
29. Discard loom switch and thin yellow wire from 3500530. (Harness from bullet terminals to switch)
30. Install ARB wiring loom 3500530 to vehicle.  
**Do not install switch or yellow wire with fuse.**

**CAUTION: Ensure that all cables are securely fastened away from sharp, abrasive or hot surfaces.**

31. Identify the black/white trigger wire from 3500530 as shown.
32. Connect the black/white trigger wire to the positive terminal on the factory fog light wire using the supplied scotch lock or a female bullet connector.
33. Tape the bullet terminal from the black wire from 3500530 to prevent short-circuits. Securely fasten it away from sharp, abrasive or hot surfaces.

**Notes:**

- Use a test light or multimeter to pick the appropriate wire to attach the loom to.
- Check the operation of all lights wired during bar fitment



34. Carefully mask the area surrounding each side of the guard as shown (RH shown).
35. Thoroughly clean the area.
36. Using Matte Black spray paint, paint the masked area.
37. Allow to dry.

**REPEAT FOR LHS**



38. If parking sensors are fitted, carefully unclip sensors and sensor loom from bumper bar and set aside for fitment to bull bar.

## FITTING PROCEDURE

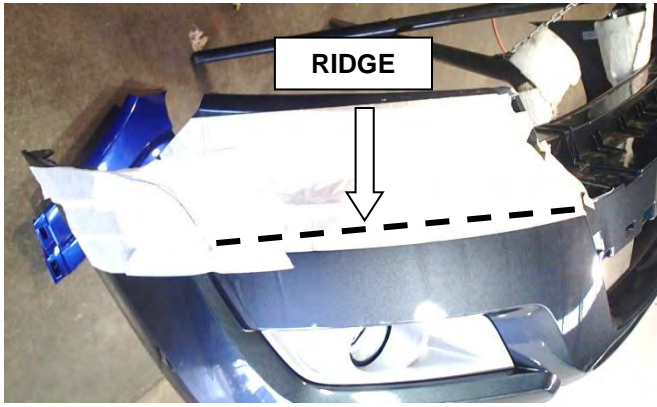

### BUMPER CUT FOR RANGER: STEP 39-61

*If fitting to Everest skip to step 62*

39. Place the bumper on a stand facing upwards.
40. Using masking tape, cover front corner section of bumper.
41. Using ridge on bumper as a guide, mark a line following the ridge across the front section of bumper as shown.

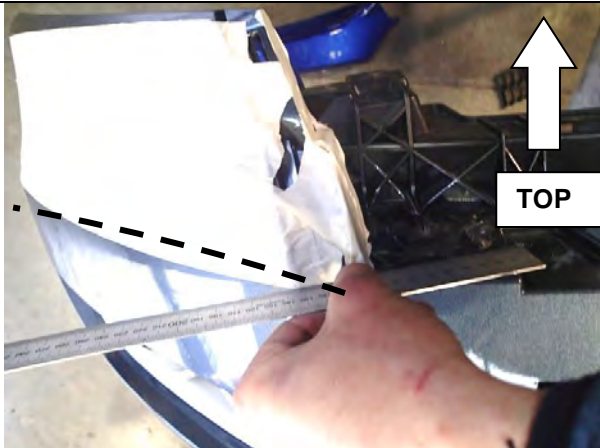

42. Continue the line onto the bumper as shown using the edge of bumper as a guide.
43. Mark a line perpendicular to bumper 30mm inwards from locating hole on top surface as shown until it meets line on bumper edge.

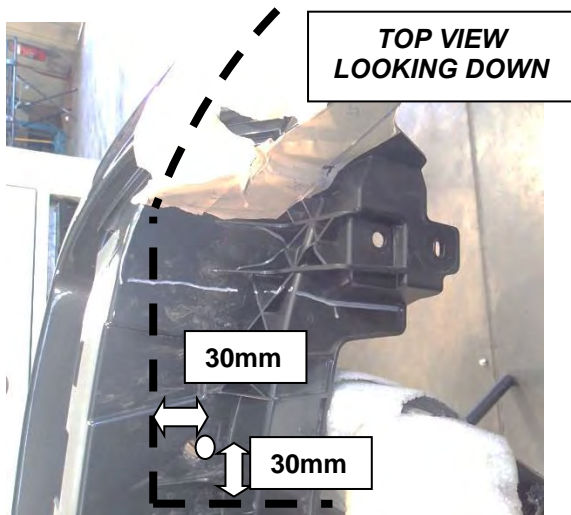

44. Using scissors carefully cut out the supplied template.

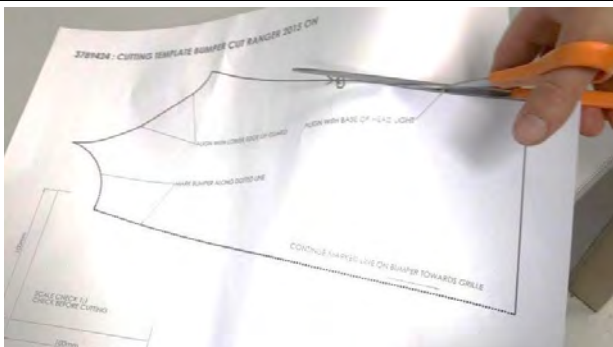

## FITTING PROCEDURE

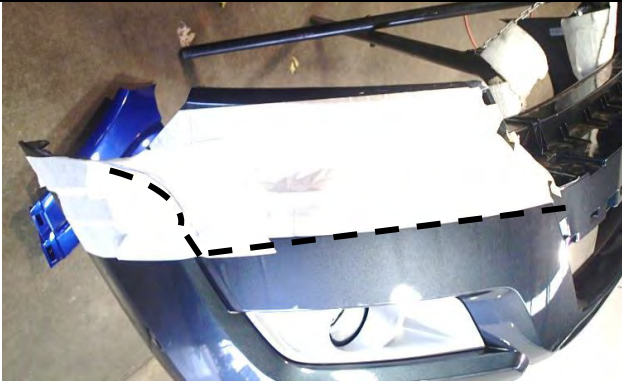

45. Position template onto bumper as shown and using a marker pen, mark contour onto bumper until it meets other line on bumper.
46. Carefully remove the template and repeat steps 39-45 for LHS.

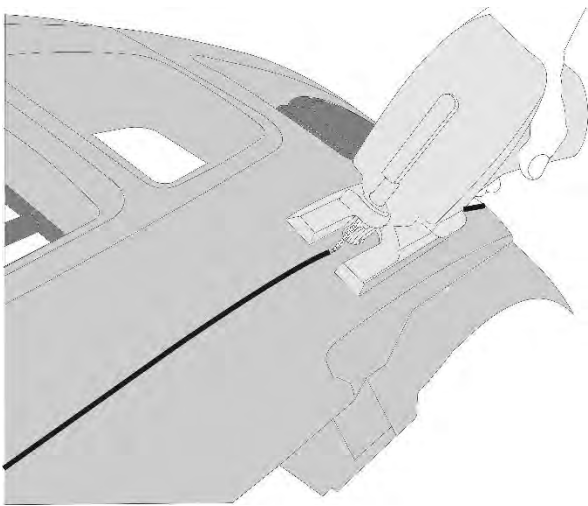

47. Using a jig saw or similar, carefully cut along marked lines.
48. De-bur the cut edges with a file or sandpaper.

**Note: It is advised that you take steps to prevent damage to the bumper when cutting such as placing extra masking tape on the kept portion of the bumper.**



**Warning: Cutting operations can result in flying metal debris, safety glasses should be worn.**

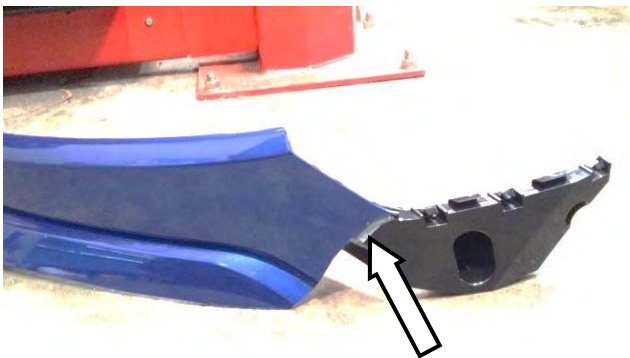

**MARK LINE HERE**

49. Position cut bumper onto bumper retention block set aside and mark a line onto block as shown using a white marker pen. (RH side shown)
50. Remove cut bumper and carefully cut along inside edge of marked line using a multitool.
51. Repeat for LHS.
52. Use a file or sandpaper to de-bur all cut edges.
53. Set aside for re-fitment later on.

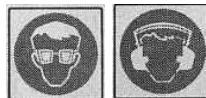

**Warning: Drilling operations can result in flying metal debris, safety glasses should be worn.**

## FITTING PROCEDURE



54. Place masking tape across front section of grille where ridge is as shown.
55. Mark line onto grille 40mm below ridge in grille as shown.
56. Using a multitool, carefully cut along marked line.
57. De-bur the cut edges with a file or sandpaper.
58. For chrome grille, position pinch weld supplied in kit along cut edge (centre the pinch weld across width of grille).

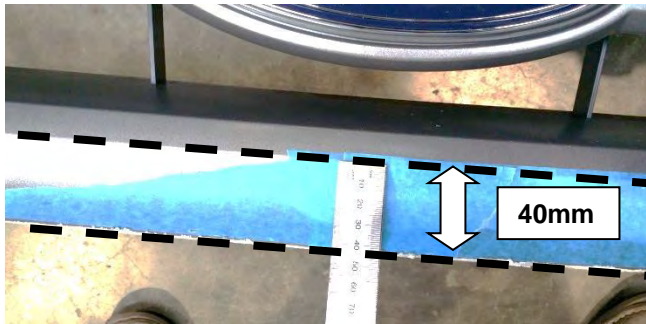

**Warning: Cutting operations can result in flying metal debris, safety glasses should be worn.**



59. Fit the two self tapping screws into the lower section of the grille to join the two parts together as shown



### IF FITTING WINCH:

*For Warn, Magnum, Smittybilt and Bushranger control boxes, additional cut out for grille is required.*

60. Using a multitool cut a 240 X 40 mm section out of lower section of grille.
61. Apply Pinch weld to cut edges.

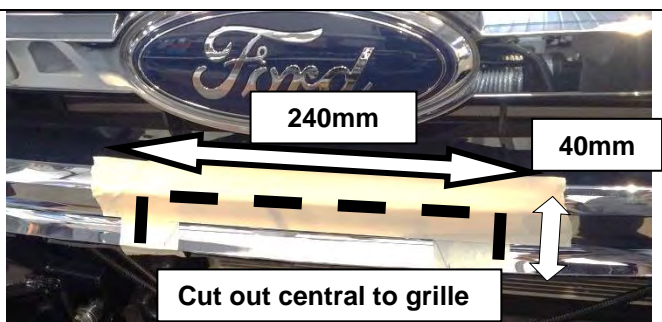

**Warning: Cutting operations can result in flying metal debris, safety glasses should be worn.**

## FITTING PROCEDURE

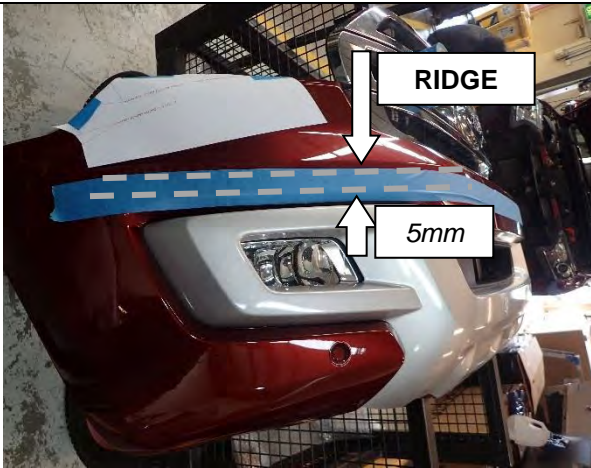

### BUMPER CUT FOR EVEREST: STEPS 62-78

62. Place the bumper on a stand facing upwards.
63. Place 50mm masking take below the ridge of the bumper.
64. On the masking tape, mark a line across the bumper 5mm below the ridge line.

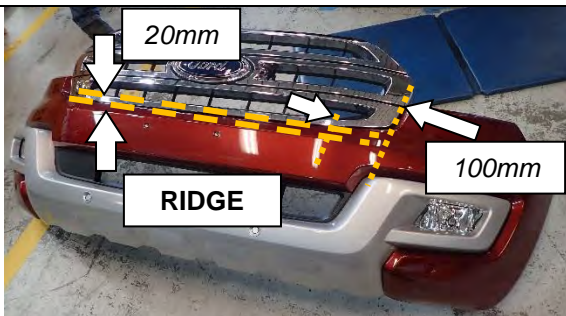

65. Below the grille place 50mm masking take above the ridge of the bumper.
66. On the masking tape, mark a line 20mm above from the ridge line.
67. On both sides of the bumper mark a vertical line 100mm inboard of the edge of the grille.

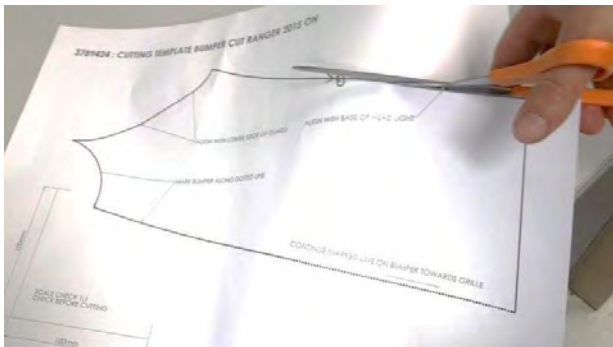

68. Using scissors carefully cut out the supplied template.

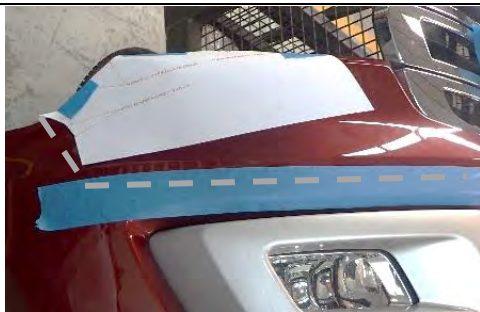

69. Position template onto bumper as shown and using a marker pen, mark contour onto bumper until it meets other line on bumper.
70. Carefully remove the template and repeat for LHS.

## FITTING PROCEDURE

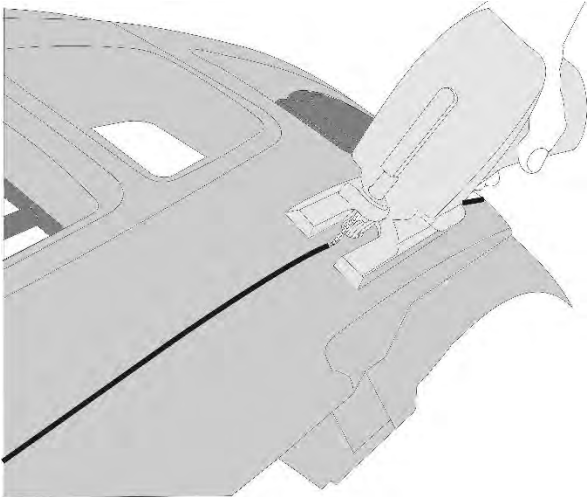

71. Using a jig saw or similar, carefully cut along marked lines.
72. De-bur the cut edges with a file or sandpaper.

**Note:** It is advised that you take steps to prevent damage to the bumper when cutting such as placing extra masking tape on the kept portion of the bumper.



**Warning:** Cutting operations can result in flying metal debris, safety glasses should be worn.

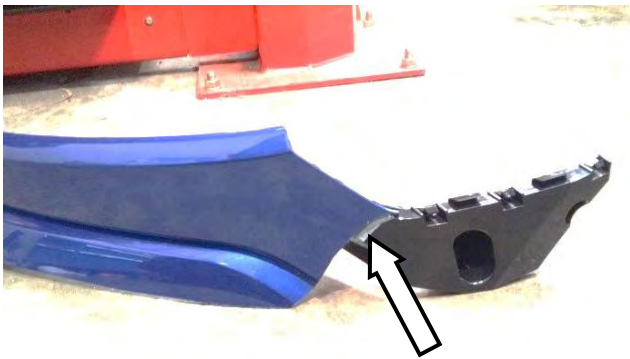

**MARK LINE HERE**

73. Position cut bumper onto bumper retention block set aside and mark a line onto block as shown using a white marker pen. (RH side shown)
74. Remove cut bumper and carefully cut along inside edge of marked line using a multitool.
75. Repeat for LHS.
76. Use a file or sandpaper to de-bur all cut edges.
77. Set aside for re-fitting later on.

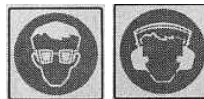

**Warning:** Drilling operations can result in flying metal debris, safety glasses should be worn.

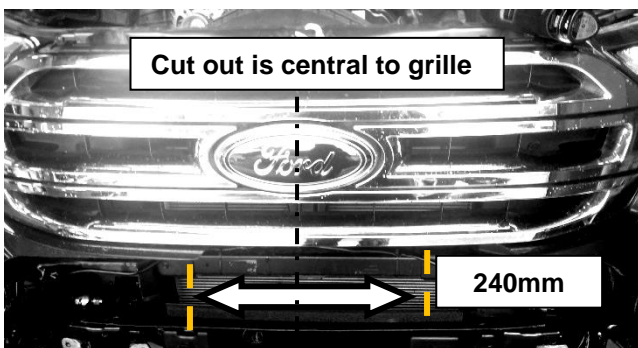

**Cut out is central to grille**

**240mm**

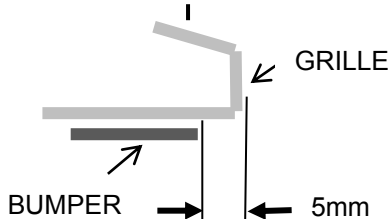

### IF FITTING WINCH:

*If fitting winch additional cut out for bumper is required.*

78. Using a multitool, cut a section 240mm wide and 5mm rearward of grille out of bumper.

### NOTE:

**-To aid in cutting of bumper removal of grille is recommended.**

**-Keep bumper as one piece.**

**-Cut out is central to bumper.**

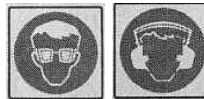

**Warning:** Cutting operations can result in flying metal debris, safety glasses should be worn.

## FITTING PROCEDURE



79. Remove clips from digital aerial antenna and disconnect at connector.
80. Using a multitool carefully cut around metallic plate corresponding to digital aerial antenna.
81. Retain antenna for remittent later on.



**Warning: Cutting operations can result in flying metal debris, safety glasses should be worn.**



82. Unbolt digital radio module and unclip wire harness.
83. Reattach digital radio module to outer most bolting position and re-attach wire harness.

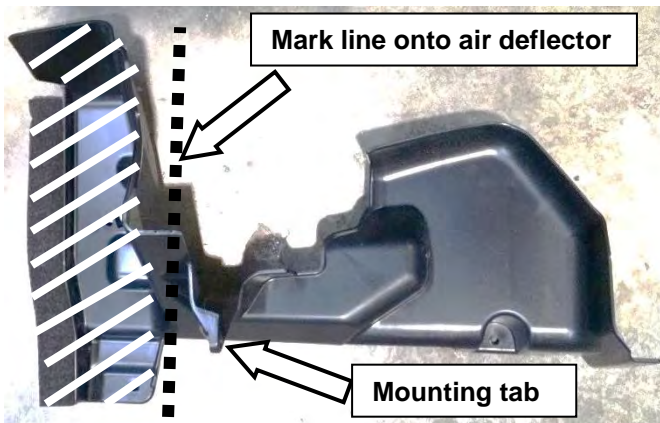

FOR RANGER:

84. Mark a line onto RH air deflector removed in step 7 as shown 30mm below mounting tab.
85. Carefully cut along marked line and dispose of lower section of air deflector.
86. De-bur the cut edges with a file or sandpaper.
87. Repeat for LH air deflector.



**Warning: Cutting operations can result in flying metal debris, safety glasses should be worn.**



## FITTING PROCEDURE

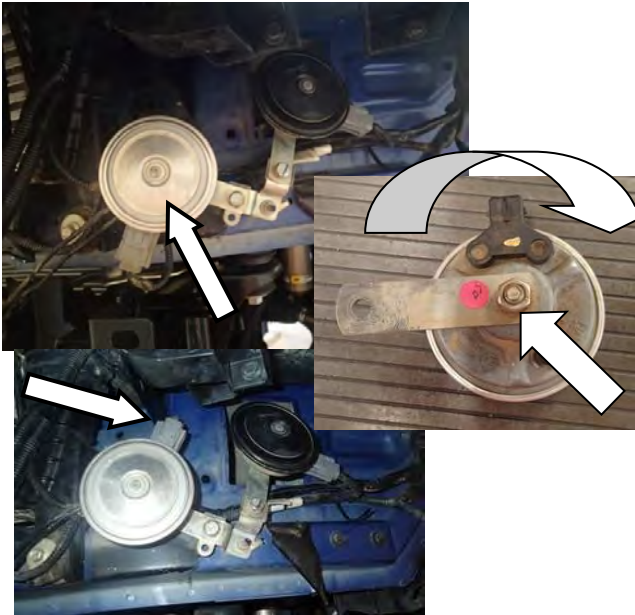

### FOR RANGER:

88. The horn & harness will require to be rotated for clearance to brackets. Unplug the harness and remove the horn by removing the mounting bolt.
89. Turn the horn over and loosen the retaining nut. Rotate the arm 180°, and tighten the retaining nut.
90. Re fit the horn in its original position and re-route the harness to the top. Use cable ties if necessary to reposition the harness.



### FOR EVEREST:

91. On LH side remove 2 X screws holding duct to vehicle.  
Carefully detach duct piece from vehicle.

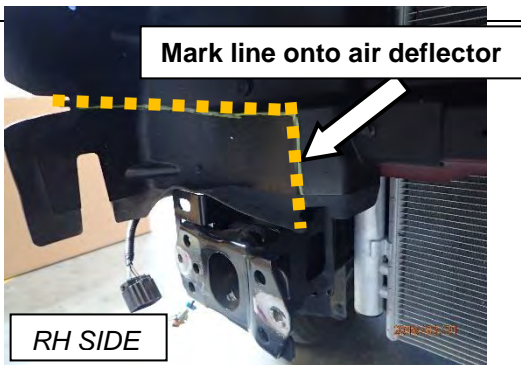

### FOR EVEREST:

92. On the LH side carefully detach sensor.
93. Mark lines on air deflectors as shown.
94. Carefully cut along marked line and dispose of lower section of air deflector.
95. De-bur the cut edges with a file or sandpaper.



**Warning:** Cutting operations can result in flying metal debris, safety glasses should be worn.

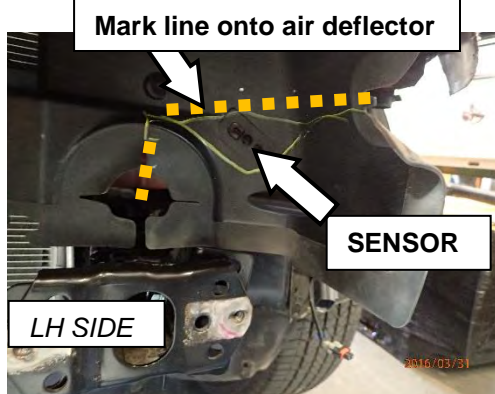

## FITTING PROCEDURE

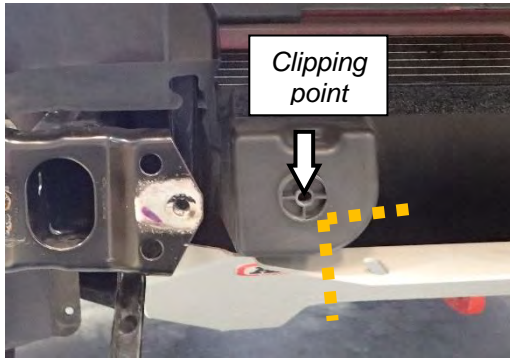

### FOR EVEREST

96. On RH side of lower air deflector mark a vertical and horizontal line 15mm from the centre of the clipping point.
97. Using the marked lines as a guide cut out a 50mm deep section from the deflector.
98. De-bur the cut edges with a file or sandpaper.



**Warning:** Cutting operations can result in flying metal debris, safety glasses should be worn.

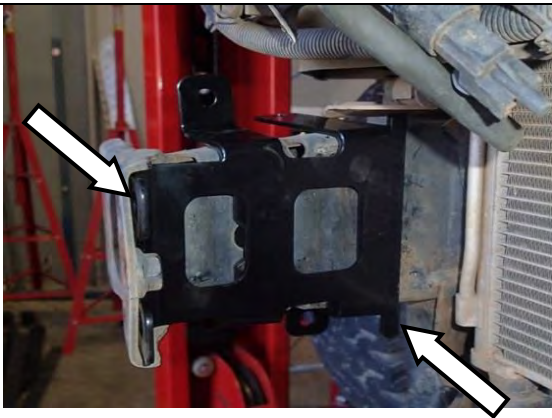

99. Fit the inner brace with the packer to the chassis rail end. Ensure that the front edge is pushed forward to the chassis flange. The brace may need to be tapped to ensure a flush fitment to the chassis is achieved.

**Note:** Ensure that packer is placed correctly, with tabs pushed against brace.

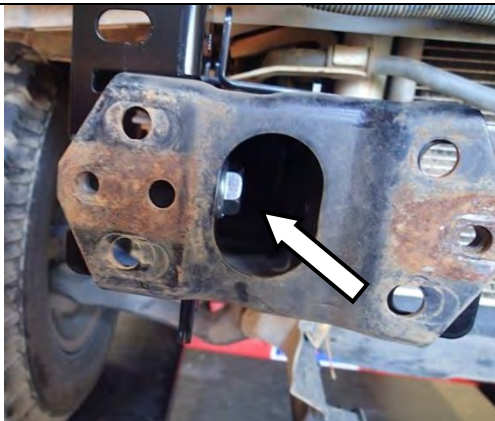

100. Fit the M16 x 35 flange bolt through the front access cut out of the front flange of the chassis.

## FITTING PROCEDURE

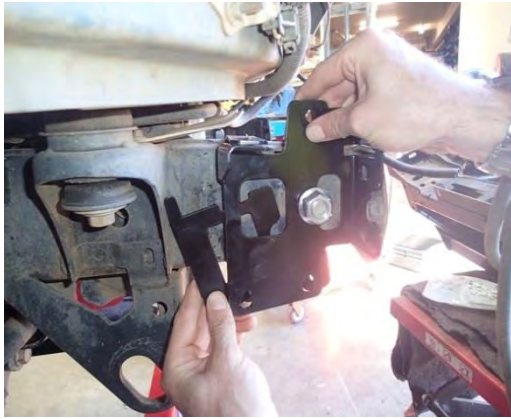

101. Loosely position the outer bracket brace with the packer to the chassis rail. Apply LOCTITE 243 then fit the M16 flange nut to hold it in place. Ensure that the front edge is pushed forward to the chassis flange.

**NOTE: Ensure that packer is placed and aligned correctly.**



102. Fit 4 x M12 x 35 bolts, 4 x M12 flat washers, 4 x M12 Flange nuts.

 M12 - 77 Nm.

**NOTE: Do not fit the M12 spring washers these will be fitted later on.**



103. Using a spanner to hold the M16 flange bolt, torque the M16 flange nut.

 M16 - 90 Nm.

**NOTE: Take care to torque as per requirement. DO NOT torque outside the specs provided.**

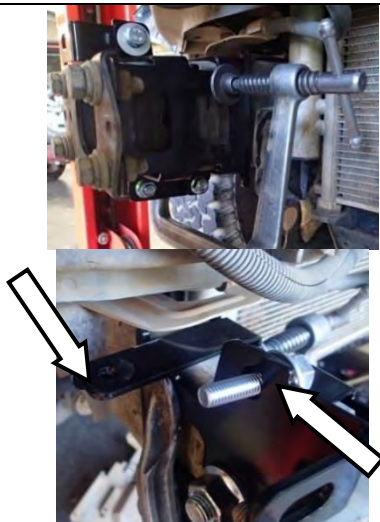

104. Using a large G-clamp, clamp the top rear corner of the outer and inner brace together. This will make the alignment of the top flange easier for fitment of the brace.

105. Fit the M10 x 1.5 x 45 bolt, M10 spring washer and M10 flat washer.

## FITTING PROCEDURE



106. Fit the 2 x M10 x 30 SEMS bolts and M10 flange nuts to the bottom of the brackets to clamp them together.
107. Fit the M10 x 30 SEMS bolt and M10 flange nut to the brace and outer bracket.
108. Fit the 15mm wide spacer between the brace and the outer bracket and then fit the M10 flange nut
109. Remove the 4 x M12 x 35 bolts, 4 x M12 flat washers and 4 x M12 flange nuts fitted in step 102 and set aside for later.

**Note: Keep all M10 fasteners loose and only finger tight at this point.**

**Repeat steps 96-109 for the LH side.**

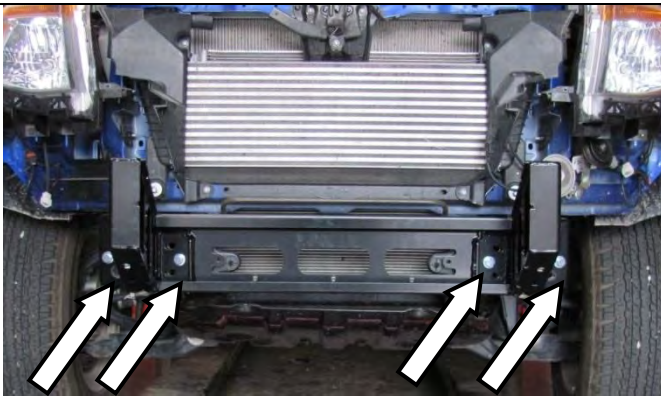

110. Attach the mount bracket to the chassis end plates using 4 x M10 x 30 SEMS bolts into the captive nuts. **Leave loose at this stage.**

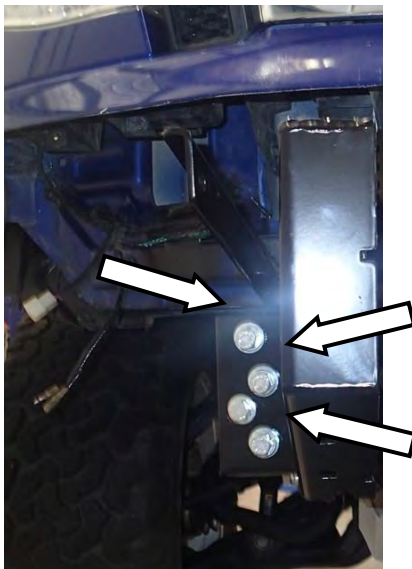

111. Attach the mount bracket to the chassis using 3 x M12 x35 bolts, 3 x M12 spring washers, 3 x M12 flat washers and 3 x M12 Flange nuts.
112. Repeat on the LH side.

 M12 - 77 Nm.

## FITTING PROCEDURE

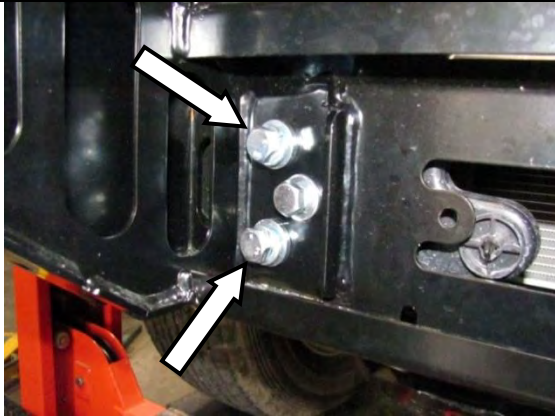

113. Place 2 x M12 x 35 bolts, 2 x M12 spring washers, 2 x M12 flat washers and 2 x M12 Flange nuts into the 2 holes on the inboard side of each chassis face plate. **Leave loose at this stage.**

114. Repeat on the LH side.

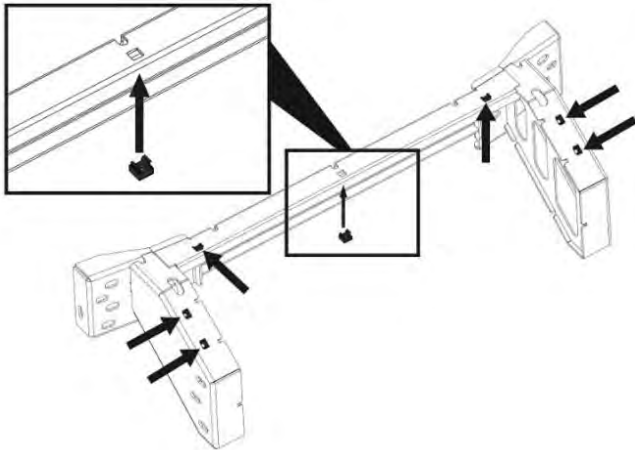

115. Fit 7 x M8 cage nuts into the mount bracket from the inside.

**Note: A flat blade screw driver can be used to aid placement of the cage nuts.**

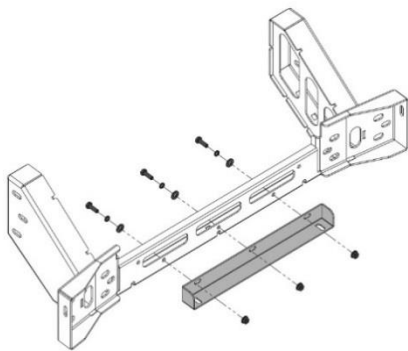

116. Attach the OE stone shield bracket to the chassis mount using 3 x M8 x 25 black bolts, 3 x M8 black flat washers, 3 x M8 black spring washers and 3 x M8 flange nuts. **Leave loose at this stage.**

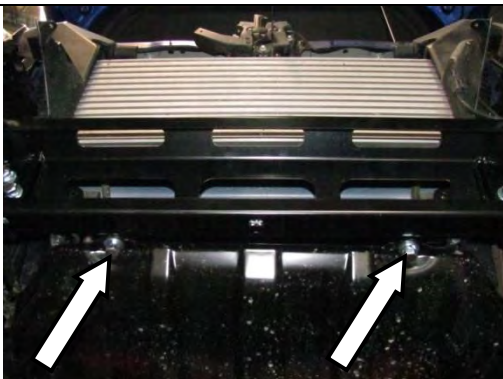





117. Re fit the OE stone shield to the bracket fitted in step 116 using 2 x M10 x 30 SEMS bolts and 2 x M10 flange nuts.

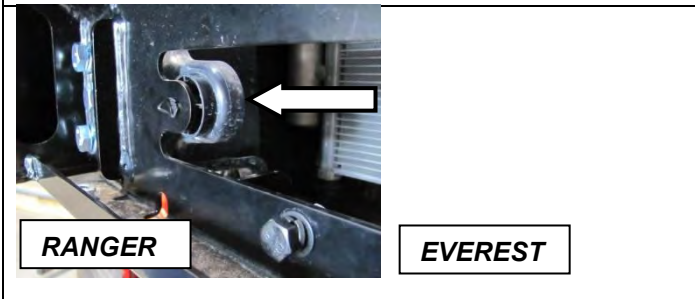
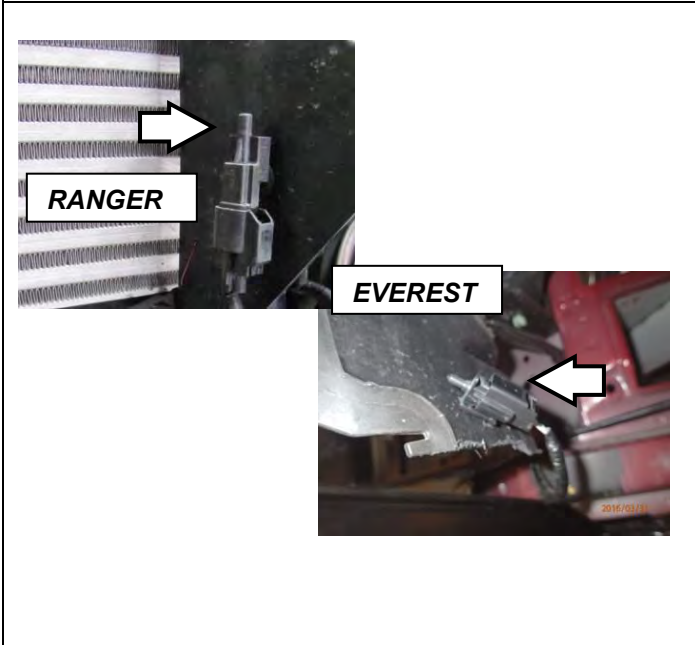

M10 - 44 Nm.

## FITTING PROCEDURE

	<p>118. Using the original plastic clips re-fit the factory air deflector to the 2 x holes in the mount bracket.</p>
	<p>FOR RANGER:</p> <p>119. Using the pegs on the sensor as a guide, Drill 2 x Ø5.5mm holes in the LH air deflector so that the sensor can be fitted approximately 40mm forward of the rear edge of the air deflector as shown.</p> <p>FOR EVEREST:</p> <p>120. Using the pegs on the sensor as a guide, Drill 2 x Ø5.5mm holes in the LH air deflector so that the sensor can be fitted approximately 20mm above of the cut edge.</p> <p>121. Push the pegs into the drilled holes, attaching the sensor.</p> <div style="border: 1px solid black; padding: 5px; display: flex; align-items: center;">   <div style="margin-left: 10px;"> <p><b>Warning: Drilling operations can result in flying metal debris, safety glasses should be worn.</b></p> </div> </div>
	<p>122. Fit 3 x M12 cage nuts to each of the cage nut plates as shown.</p>
	<p>123. Fit the bumper and grille back onto vehicle using reverse sequence to removal process</p> <p>124. Fit pinch weld to lower cut edge of grille (RANGER ONLY)</p> <p>125. Drill an Ø2mm hole through each end corner of the bumper into the guard sheet metal.</p> <p>126. Attach the bumper to the guards using the Phillips head self-tapping screws.</p> <p>127. Fit pinch weld on exposed edge of bumper cut.</p>

## FITTING PROCEDURE

**Note: If fitting a winch proceed from here using fitting instructions 3789337 supplied with 3500720 winch install kit. Once the winch is fitted please continue to step 131. If no winch is being fitted continue from here.**

128. Slide the winch cover panel from the bottom up until it is level with the top face of the bar.

129. Fit the winch cover panel to the bar using 4 x M6 x 20 hex bolts, spring washers, flat washers and flange nuts.

**Warning: Be careful not to scratch the finish of the winch cover panel.**

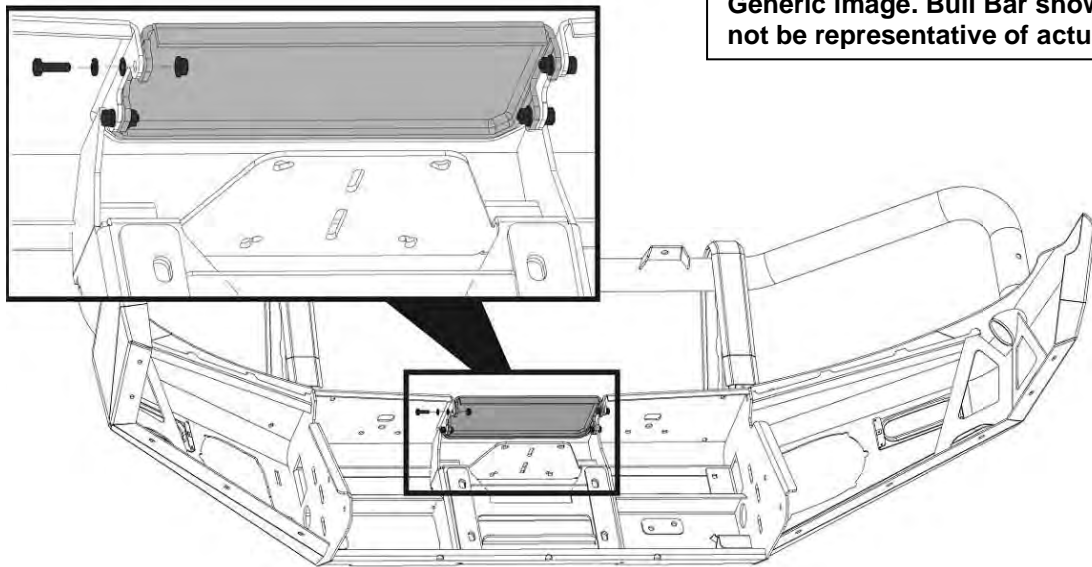

**Generic image. Bull Bar shown may not be representative of actual product.**

130. Fit the number plate bracket to the top face of the lower-centre pan on the bar using 3 x M6 x 20 hex bolts, spring washers, flat washers and flange nuts.

**Note: If you are fitting a winch, fit the folding number plate bracket supplied in winch install kit "3500720 WINCH INSTALL KIT" – See fitting instructions 3789337**

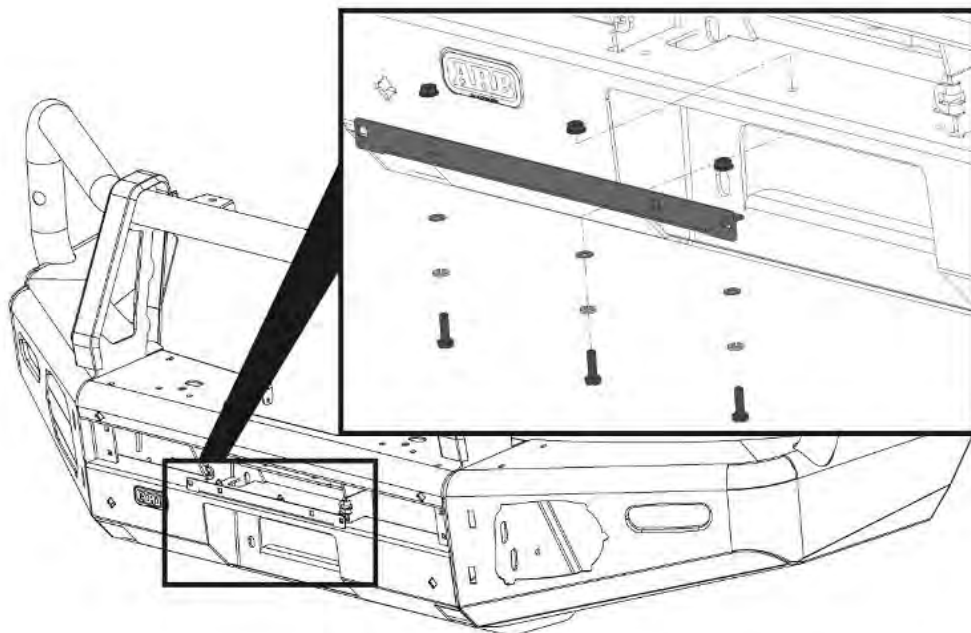

**Generic image. Bull Bar shown may not be representative of actual product.**

**Note: The following steps show the fitment of the plastic moulded parts. The mouldings are supplied in kits along with all fasteners required for fitment. It is important that the fasteners supplied with each kit are only used for the mouldings from the same kit.**

**The kits included in this bar kit are as follows:**

131. Layout the contents of each of the following kits ensuring the contents are kept separate from each other.

Kit No.	Description
5100200	BUFF KIT 2PCE FRONT SECTION
5100210	BUFF KIT 2PCE REAR UPRIGHT BAR
3500880	SPLIT PAN MESH KIT
3163082	FOG SURROUND KIT

132. Mark the grille panel to be cut at the 810mm marks at each end on the back face.

**Note: When marked, double check the measurement with a measuring tool.**

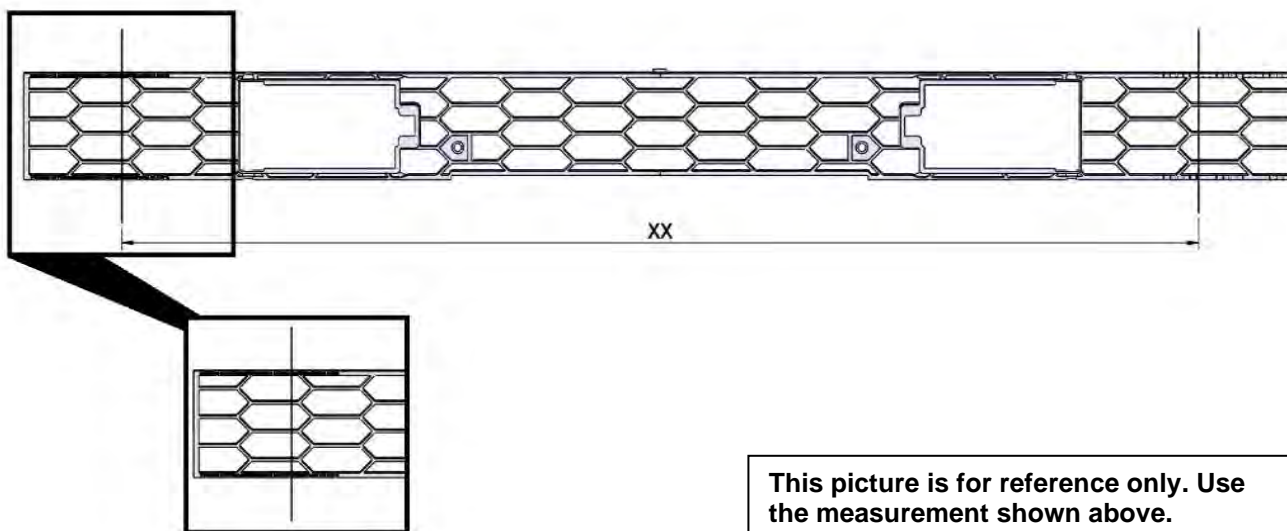

133. Use a hacksaw or similar cutting tool to carefully cut the grille panel at the positions marked in the step above.

134. Discard the off cuts and clean up the cut edges using a file or sandpaper.

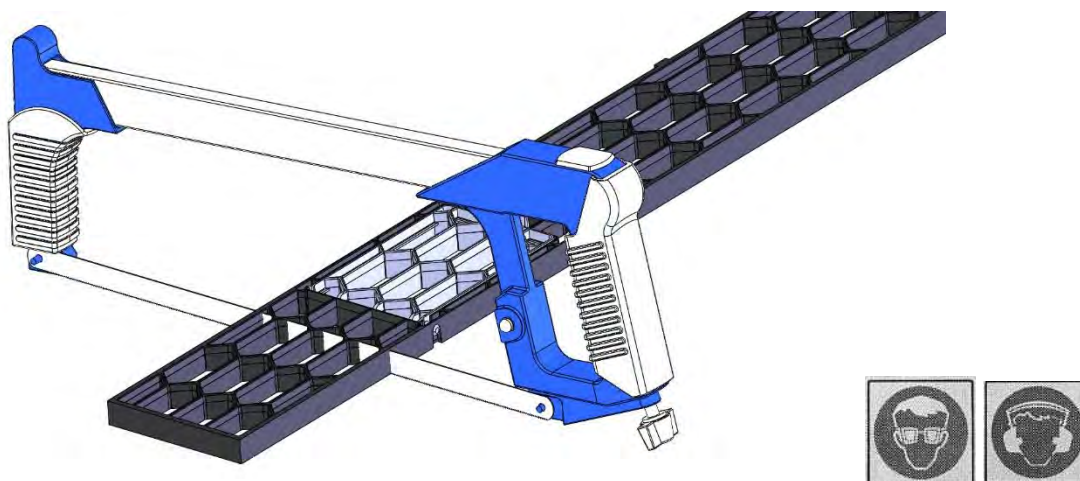



135. Insert the 6 x plastic grommets into the 6 square holes in the front face of the bar.
136. Insert the grille into the bar so that the hatches open outward (facing the front of the bar).
137. Attach the grille to the centre of the bar using the short screws into the grommets fitted above.
138. Attach the ends of the grille to the bar using the longer screws, through the clamp plates into the remaining grommets.

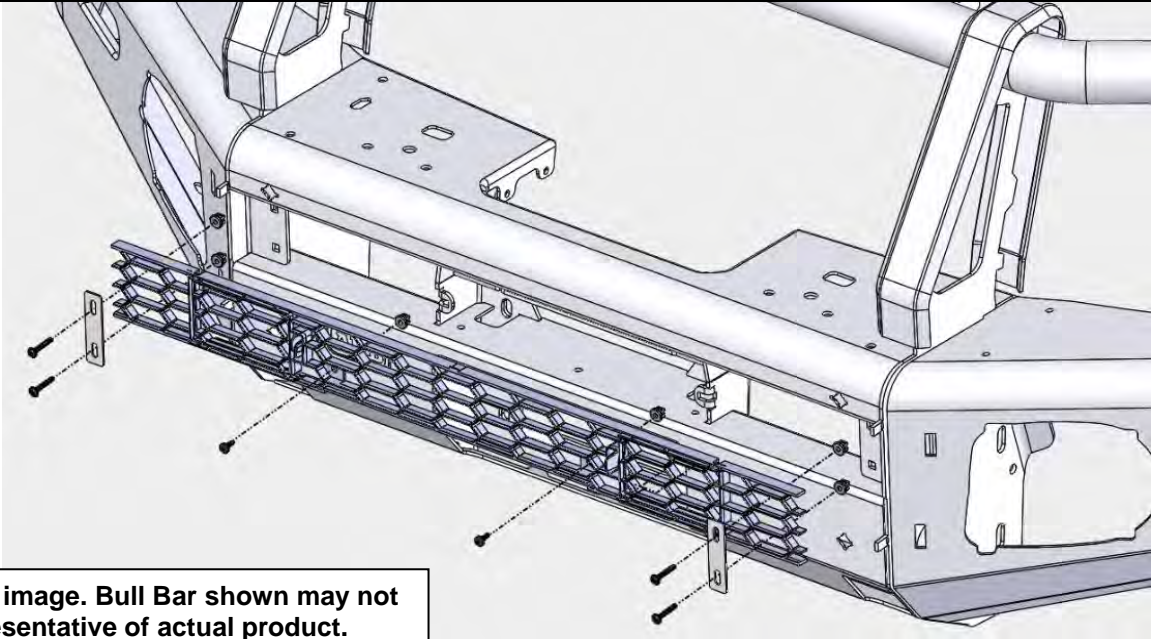

**Generic image. Bull Bar shown may not be representative of actual product.**

139. Fit the rubber intersection mouldings to the base of each upright cover strap.

**Generic image. Bull Bar shown may not be representative of actual product.**

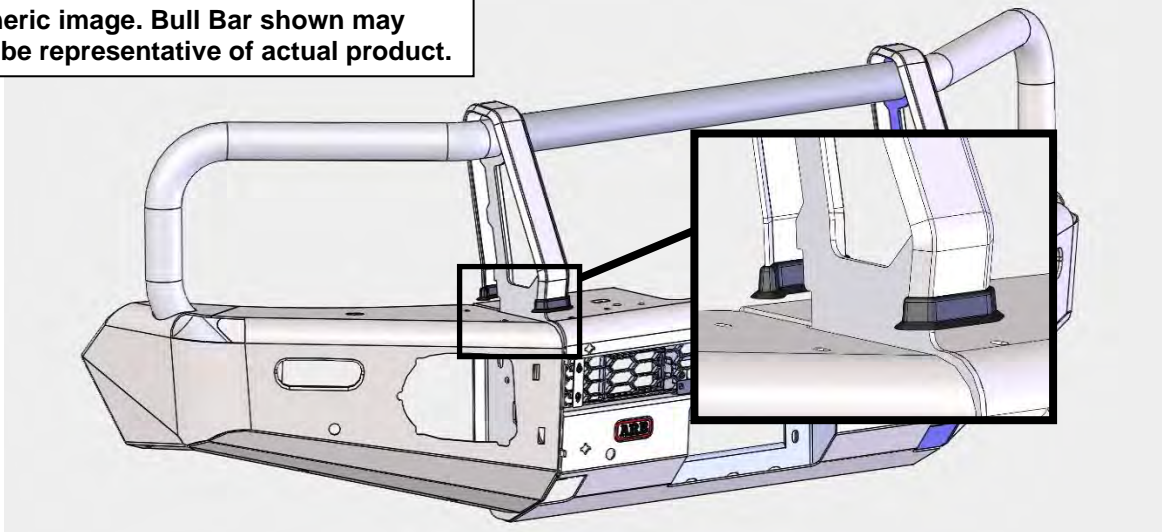

140. From the rear of the bar, slide the rear buffer sections under the rubber mouldings.

Fit 4 x screws and washers. Do not tighten screws. Leave enough play in buffers for adjustment later.

**Note:** Ensure that the skirts of the rubber intersection mouldings are not folded back on themselves and are sitting flat against the buffers.

Generic image. Bull Bar shown may not be representative of actual product.

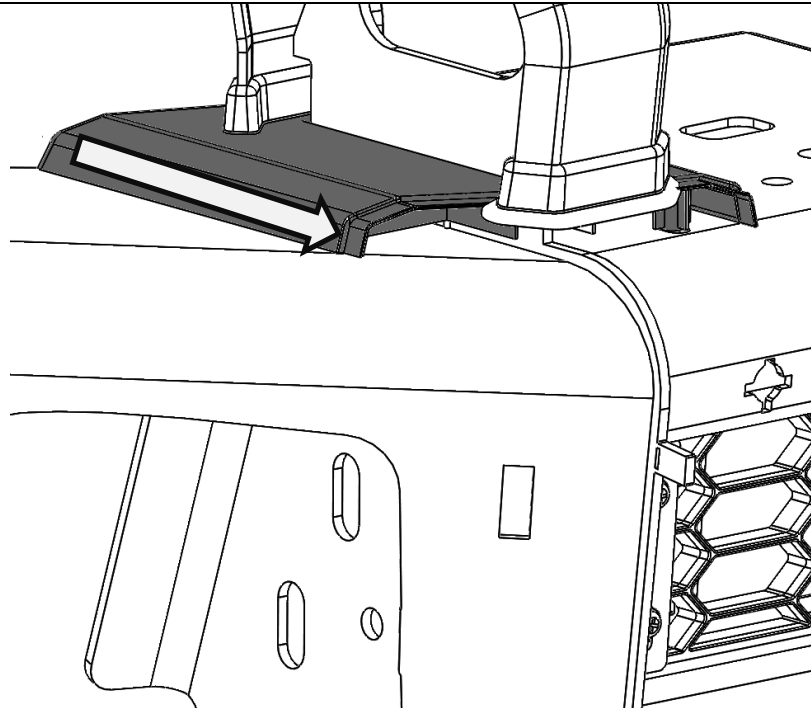

Fit washers under screw heads

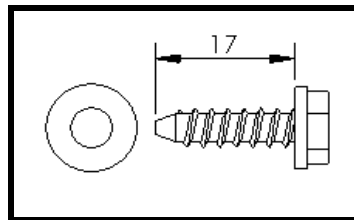

141. By aligning the front buffer with the tongue of the rear buffer, attach the front buffers to the front face of the bar. Ensure each buffer sits flat against the face of bar and is keyed into the top section of the rear buffer.

Secure wing side using retaining clips.

Secure inner side using the angled cup washers, flat washers and screws.

**The widest point of the cup washers goes to the top of the bar.**

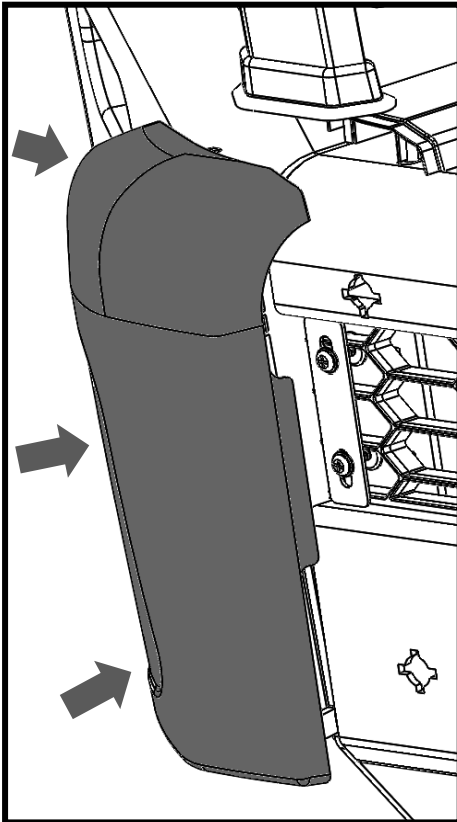

Generic image.  
Bull Bar shown  
may not be  
representative of  
actual product.

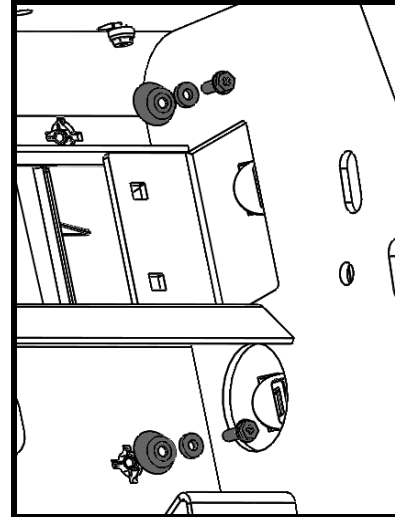

Fit washers under screw heads.

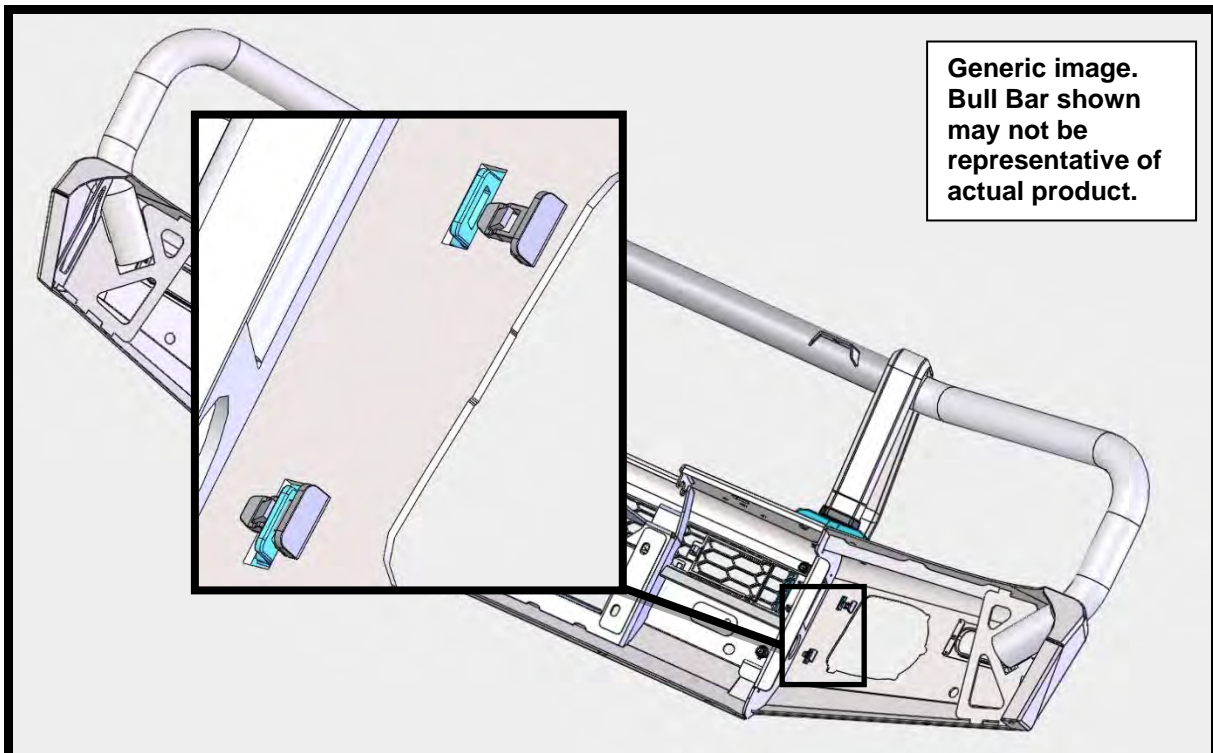
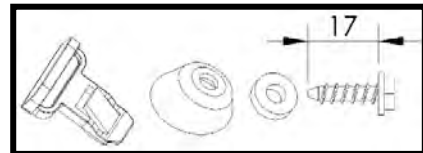

Generic image.  
Bull Bar shown  
may not be  
representative of  
actual product.

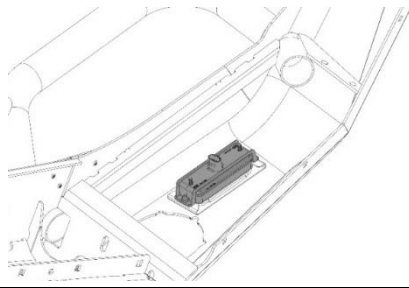

142. Fit the small plastic grommets to the bar and attach the combination LED lamps to the bar using the screws provided with the lamp kit.

**Caution:** Cable tie all cables together and keep all cables clear of sharp edges and moving parts.

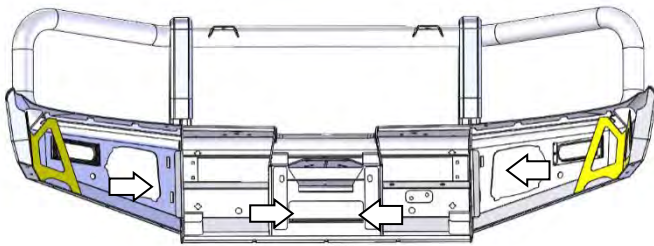

**If fitting parking sensors continue from here. If not proceed to step 159.**

**NOTE:** Painting over sensors is not recommended as sensor operational faults can result. ARB recommends purchase of correctly colour coded sensors from a Ford dealer.

**HINT:** Mark sensors and loom to ensure sensors are installed back to the same location.



143. Carefully remove the parking sensors from the loom. Discard all of the Manufacturer's clear rubber grommets that fit between the sensors and the bumper holes.

**Note:** When fitting parking sensors to the bar it is important that they are installed in the correct orientation. The arrows to the left show the direction the plug end of the sensors should face.

### Sensor Housing Front

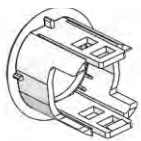

### Sensor Housing Rear

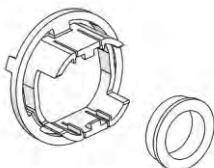

### Parking Sensor Washer

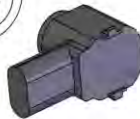

### Parking Sensor

144. Fit the Sensor Housing Front to the bull bar. Placing the housing through the bar from the front of the vehicle.

### IMPORTANT:

**Check orientation of sensor housing. Front Sensor housing must be parallel to ground (as shown below).**

145. From the rear of the bar clip the Sensor housing rear to the front housing. Check that both clips are engaged properly. If clips don't engage apply pressure on the outer ring of the rear housing.

146. Replace the manufacturer's clear rubber grommets with the new rubber grommets supplied.

147. Clip the sensor into the housing. Check that both clips are engaged properly.

**NOTE:** Loom connectors should all be pointing toward the centre of the car.

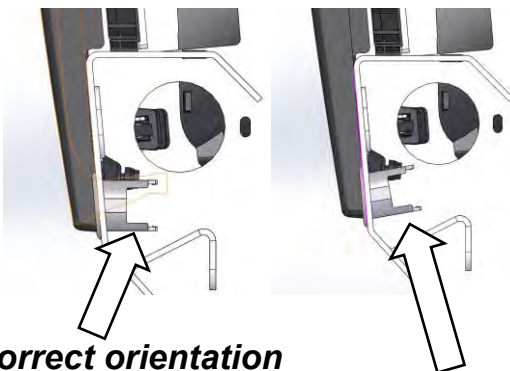

**Correct orientation**

**In-Correct orientation**

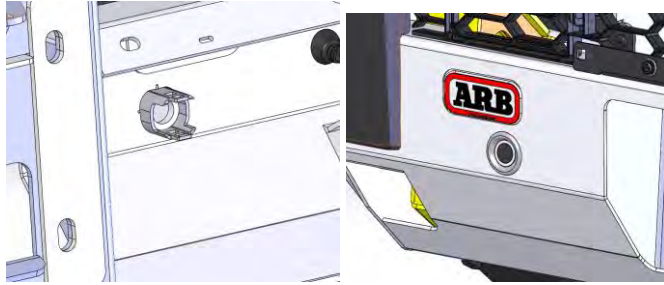

**IMPORTANT:**

- 148. Ensuring the rubber grommet remains on sensor.
- 149. Ensure sensor is central in hole and not pressed to one side.
- 150. Ensure sensor installed in the correct orientation.
- 151. Reattach parking sensor to loom.

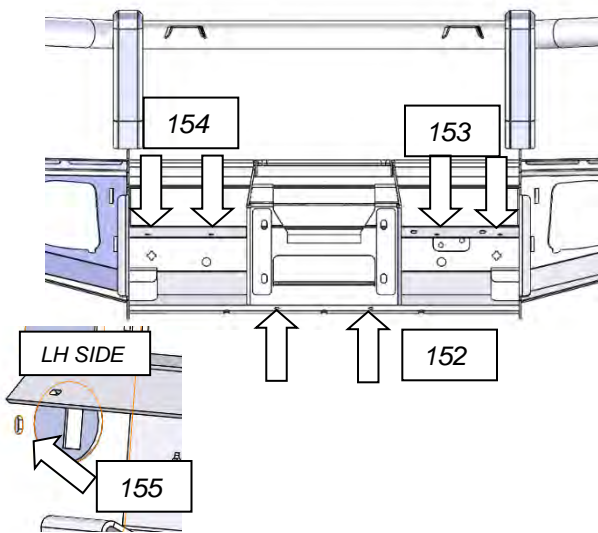

- 152. Route the parking sensor loom through 2 X 45mm holes in bull bar uprights.
- 153. Connect loom to sensors.
- 154. Centre loom on bar, using 2 x cable ties secure loom to bull bar using 2 x slots.
- 155. On RH side using 2 x cable ties gather extra loom length and secure to bar using 2 x slots.
- 156. On LH side using 2 x cable ties and secure to bar using to bull bar using 2 x slots.
- 157. On RH & LH side using 2 x cable ties secure loom bar upright using 2 x slots.

**Note: Do not shorten or tamper with wiring harness as it will affect performance.**

**Wiring harness must not be pulling on sensor.**

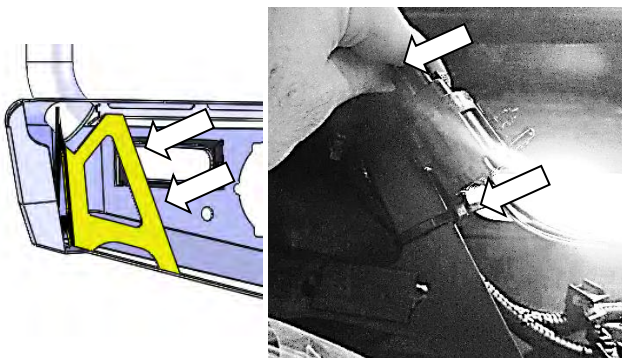

- 158. On outer LH side of bull bar using 2 x cable ties secure loose loom length and parking sensor connector to brace.

## FITTING PROCEDURE



159. With the assistance of another person, place the bar on the mount brackets.

**Warning: Due to the weight of the bar and winch if fitted, it is advised that you use some form of mechanical assistance when lifting the bar onto the vehicle such as an elevating trolley.**



160. Attach the bar to the mount bracket using 2 x M12 x 35 bolts, 2 x M12 spring washers and 2 large diameter M12 flat washers, into the nut plates which are placed inside the box upright sections of the mount bracket. **Leave loose at this stage.**

161. Repeat for LH side

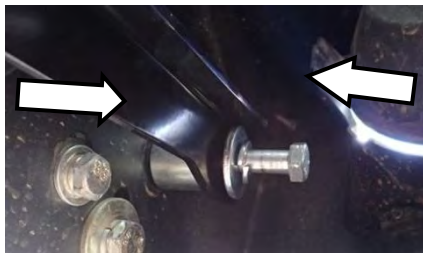

162. Fit the 35mm wide spacer and the M12 x 1.75 x 80 bolt, M12 washer and M12 spring washer. **Leave loose at this stage.**

163. Repeat for LH side.

## FITTING PROCEDURE

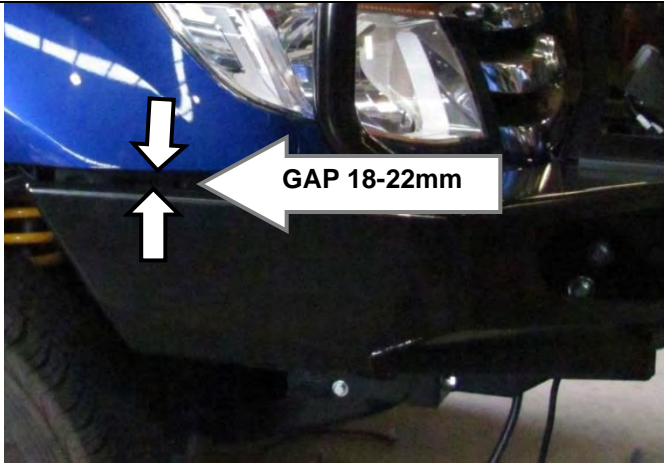

164. Centralise the bar and tighten all mounting bracket related fasteners to the specified torque.
165. Position the bar so that it is level and there is a gap between the top face of the wings and the bottom edge of the guards of 18-22mm and the wing tips are aligned with the edge of the wheel arch.
166. Tighten all remaining fasteners to the specified torques for M10 and M12 sizes.



M10 - 44 Nm.



M12 - 77 Nm.



167. Double check the position of the bar.
168. When happy with the position of the bar drill 2 x Ø10mm pinning holes using the pre-cut holes in the bar uprights as guides.
169. Use paint or rust protection on the drilled holes.
170. Pin the holes using 2 x M10 x 30 SEMS bolts and 2 x M10 flange nuts.
171. Repeat for LH side.



M10 - 44 Nm.



**Warning: Drilling operations can result in flying metal debris, safety glasses should be worn.**



172. Assemble and install combination light surrounds (p/n 3500530) as per instructions no. 3789190 supplied with surround kit. Note: Optional fog lamps can be installed at this point as per fitting instruction supplied with fog lamp kit no. 3500640.
173. Connect indicator loom and reconnect parking sensor loom, secure cabling. Check the operation of parking sensors and all lights wired.

**CAUTION: Cable-tie all cables together and keep all cables clear of sharp edges and all moving parts.**

## FITTING PROCEDURE

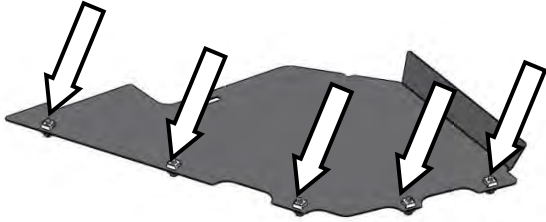

174. Fit 5 x M6 cage nuts to each of the under wing panels as shown.



175. Fit the RH under wing panel to the RH wing as shown and attach using 5 x M6 x 20 hex bolts, 5 x M6 spring washers and 5 x M6 flat washers.

176. Repeat on the LH side.

 M6 - 9 Nm.

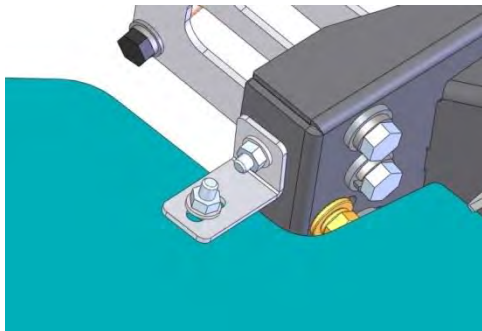

177. On each side of the bar attach the under wing panel to the mount bracket with the wing panel bracket using 2 x M8 x 25 hex bolts, 2 x M8 spring washers, 2 x M8 flat washers and 2 x M8 flange nuts.

 M8 - 22 Nm.

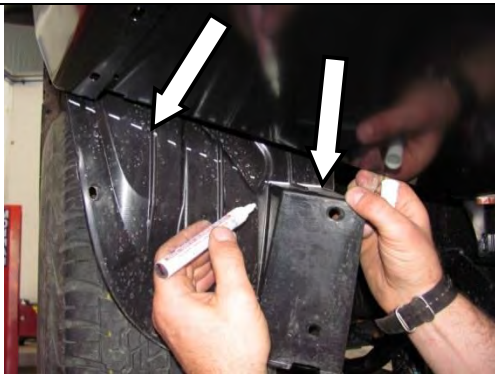

178. On the plastic OE inner guards, mark lines from the bottom corners of the bar wing tips down to the square corners in the inner guards. Continue the line along the horizontal corner.

179. Using multitool, carefully cut along the marked line and discard the bottom section.



## FITTING PROCEDURE

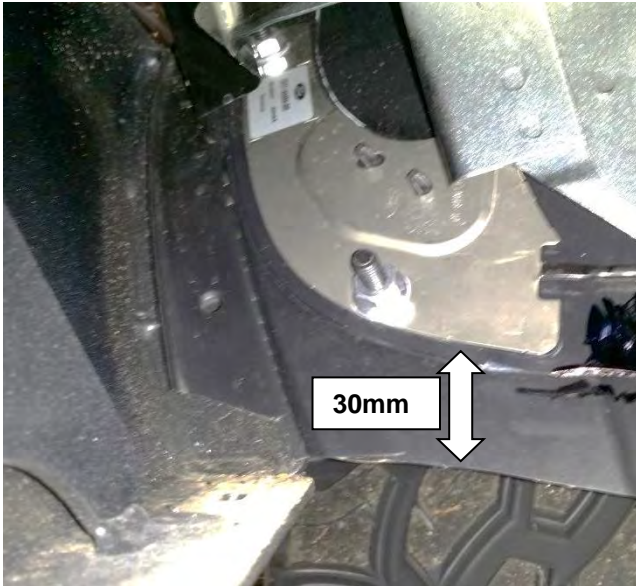

180. Remove wing under panel.
181. Position digital antenna removed in step 81 30mm above cut performed on wheel arch guard as shown.
182. Mark and drill two 10mm holes corresponding to existing holes in digital antenna.
183. Fasten digital antenna to new location using 2x M8 x 1.25 x 25 BTN HD bolts, 2x M8 spring washers, 2x M8 flat washers and 2x M8x1.25 flange nuts.
184. Plug digital antenna lead back in and check its function by turning radio on.
185. Re-fit wing under panel and tighten fasteners.
186. Push the inner guards inside the under wing panels.

 M6 – 9Nm
  M8 – 22Nm

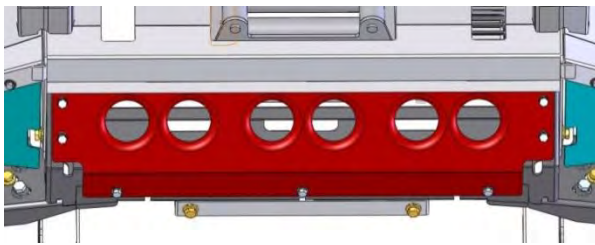

187. Attach the centre stone shield to the mount bracket using 7 x M8 x 25 hex bolts, 7 x M8 spring washers and 7 x M8 flat washers into the cage nuts fitted in step 115.

 M8 - 22 Nm.

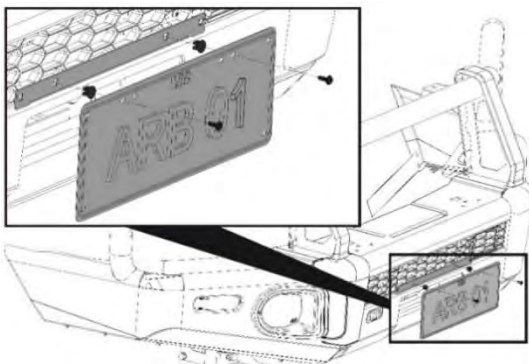

188. Fit the plastic plugs into the square holes in the licence plate bracket. Fit the number plate to the bull bar using the black self-tapping screws.

**Note: Non-winch set up shown, for vehicle's fitted with winch fit the plastic plugs into the square holes in flip up panel supplied with winch install kit 3500720.**

**NOTICE: ONCE SUMMIT BAR IS FITTED:**

- ◆ Ensure all bolts are tensioned correctly.
- ◆ All wiring is clear of sharp edges or moving surfaces and secured properly.
- ◆ Piping is secured well away from sharp or moving components.
- ◆ Check operation of winch, if fitted.
- ◆ Check all wiring and connections to turn signal lamps, sensors, headlamp washers etc. are functioning correctly.
- ◆ Misalignment of parking sensor to hole in bull bar may cause malfunction, if fitted.
- ◆ Test operation of parking sensors after fitment, if fitted.

**NOTE:**

If parking sensors are fitted, do not add any accessories to the Bull Bar on or around the sensors, this may affect the function of the sensors.

Sensors may not function well under the following conditions:

Ensure all bolts are tensioned correctly:

- ◆ After the vehicle, has been sitting out in hot or cold weather.
- ◆ When the system is affected by electrical equipment or devices generating an ultrasonic wave.
- ◆ When operating in bad weather

**FITTED PRODUCT**

