



**AEROMOTIVE**  
**Part # 19301/19302/19307/19308/19313/19314**  
**INSTALLATION INSTRUCTIONS**

This product is not legal for sale or use on emission-controlled vehicles except when used as a direct replacement part matching OEM specification.

**WARNING!**



Always be aware of flammable situations. Drilling and grinding can be potential ignition sources. Extinguish all open flames, prohibit smoking and eliminate all sources of ignition in the area of the vehicle and workspace before proceeding with the installation. Ensure you are working in a well ventilated area with an approved fire extinguisher nearby.

**WARNING!**



Installation of this product requires modification to a fuel tank/ the fuel system, failure to satisfy all safety considerations will result in fire, explosion, injury and/or loss of life to yourself and/or others. All fuel system components **MUST** be located as far from heat sources as possible, like exhaust, engine block, etc.

**WARNING!**



Mechanical and hydraulic lifting devices can tip over or lower accidentally due to incorrect maneuvering or technical errors. A falling object can cause injury and/or loss of life to yourself and/or others. When working under the vehicle, always use stands, and ensure that the ground or floor is stable and level. Never crawl under a vehicle which is only supported by a jack.

**WARNING!**



The fuel system is under pressure. Do not open the fuel system until the pressure has been relieved. Refer to the appropriate vehicle service manual for the procedure and precautions for relieving the fuel system pressure.

**CAUTION!**



When installing this product always wear safety glasses and other appropriate safety apparel. A drilling operation will cause flying metal chips. Flying metal chips can cause eye injury.

**CAUTION:**



Installation of this product requires detailed knowledge of automotive systems and repair procedures. We recommend that this installation be carried out by a qualified automotive technician. Careless installation of this product can result in damage to the product, injury or loss of life to yourself and/or others.

## Compatible Fuels:

Pump Gas  
Race Gas  
E85  
Alcohol/Ethanol

To use this stealth fuel cell in your vehicle's fuel system, **you must do the following:**

- **A by-pass style fuel pressure regulator must be used in the system.**
- **Utilize high pressure fuel lines, fittings and o-rings for all connections from the fuel tank to the fuel pressure regulator.**
- **For long term driving applications where continuous run times exceed 30 minutes Aeromotive recommends maintaining at least a half-full tank of fuel.**

**Failure to follow the above may result in fuel leakage, bursting of the fuel lines, poor vehicle performance and/or decreased fuel pump life! Improper installation will void all warranties for this product!**

Aeromotive system components are not legal for sale or use on emission controlled motor vehicles

The enclosed Aeromotive fuel pump utilizes a AN-10 ORB (O-ring Boss Ports) style outlet port; these ports are **NOT PIPE THREAD** and utilize **NO THREAD SEALANT**.

Maximum continuous operating pressure should not exceed 70 psi.

**The following steps are typical of most installations:**

1. Find a good mounting location on your vehicle for the Aeromotive Stealth Fuel Cell. Remove any sharp edges from the area around the fuel cell prior to mounting. Mount the cell in accordance to the requirements set forth by your racing sanctioning body. Fuel cells should always have good solid floor support under the cell for the weight of the fuel. The top, bottom and sides of the cell must have the proper support. To make securing the Aeromotive Stealth Cell easier, strap kits are available from most major fuel cell manufactures.

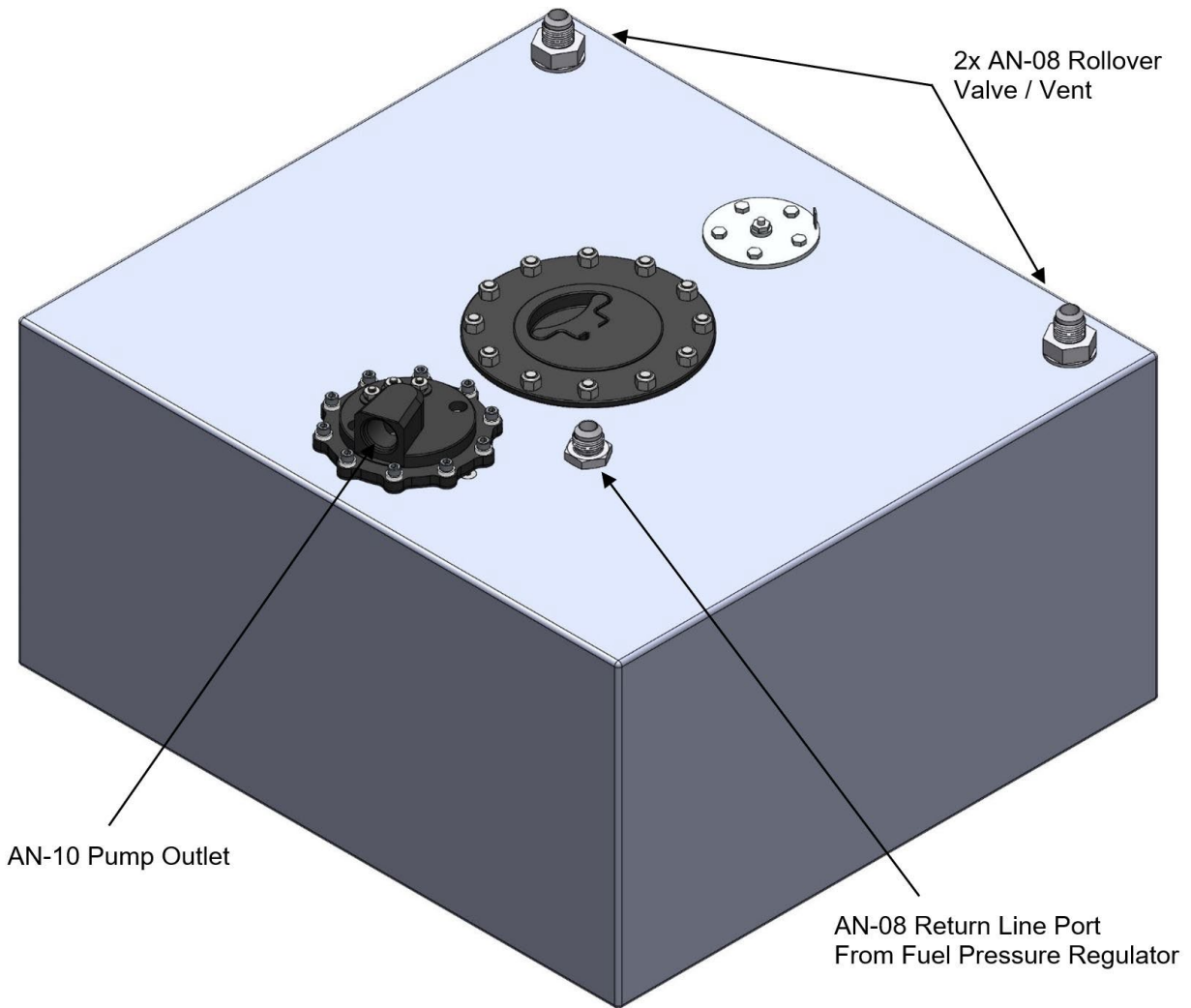

2. Connect AN-08 lines to the tank vent fittings. Tank vent lines must be run outside the vehicle.
3. Connect the fuel pump outlet to a fuel filter, Aeromotive p/n 12350 or 12339 (10 micron). **Make sure you use high pressure (150 psi minimum) fuel line for this connection!**
  - For AN-10 Line, Aeromotive p/n 15608, (AN-10 ORB to AN-10 Flare Union)
  - For AN-08 Line, Aeromotive p/n 15610, (AN-10 ORB to AN-08 Flare Union)
  - For AN-06 Line, Aeromotive p/n 15609, (AN-10 ORB to AN-06 Flare Union)

4. If you are running an EFI System, connect the fuel filter outlet to the fuel rail(s) and then to a bypass style fuel pressure regulator as in the following diagrams. **Make sure you use high pressure (150 psi minimum) fuel line for these connections!** For optimum fuel system performance in EFI applications, Aeromotive recommends a balanced system with the fuel pressure regulator as the last component in the system as shown in the following diagram.

## BRUSHLESS A1000 IN-TANK Dual Fuel Rail - Fuel Injected

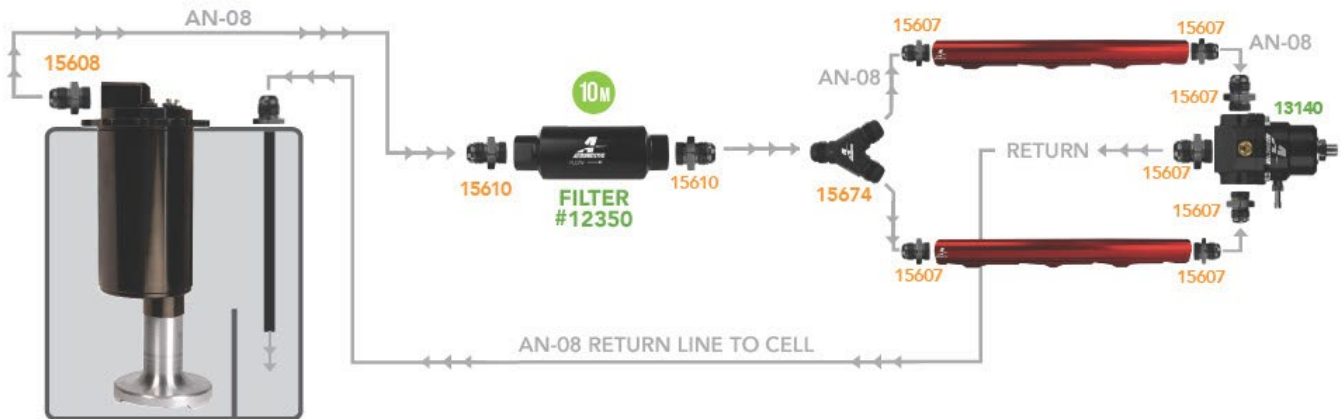

## BRUSHLESS ELIMINATOR IN-TANK Dual Rail - Fuel Injection

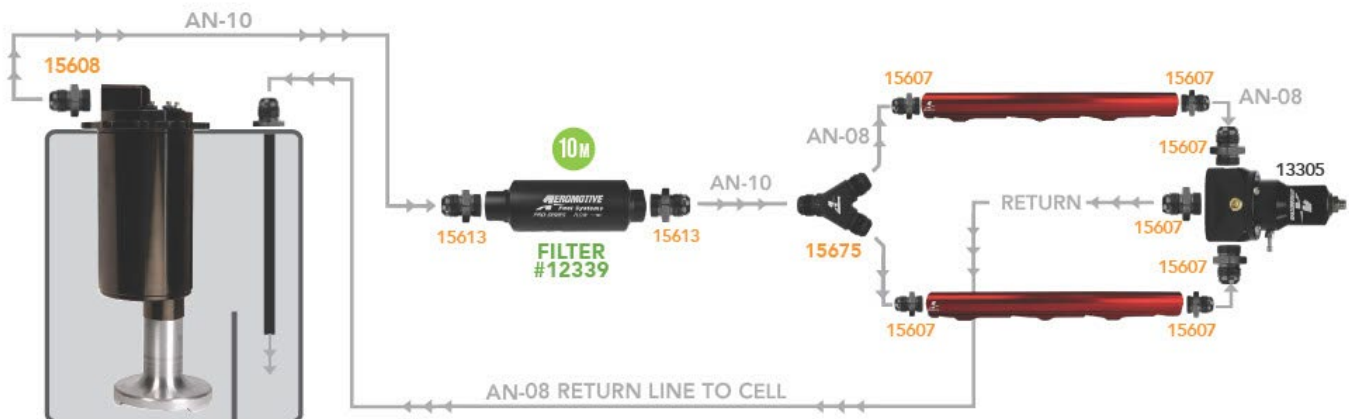

5. If you are running a Carbureted System, connect the fuel filter outlet to a bypass style fuel pressure regulator and/or fuel log as in the following diagrams.

# BRUSHLESS A1000 IN-TANK Dual Feed Carbureted

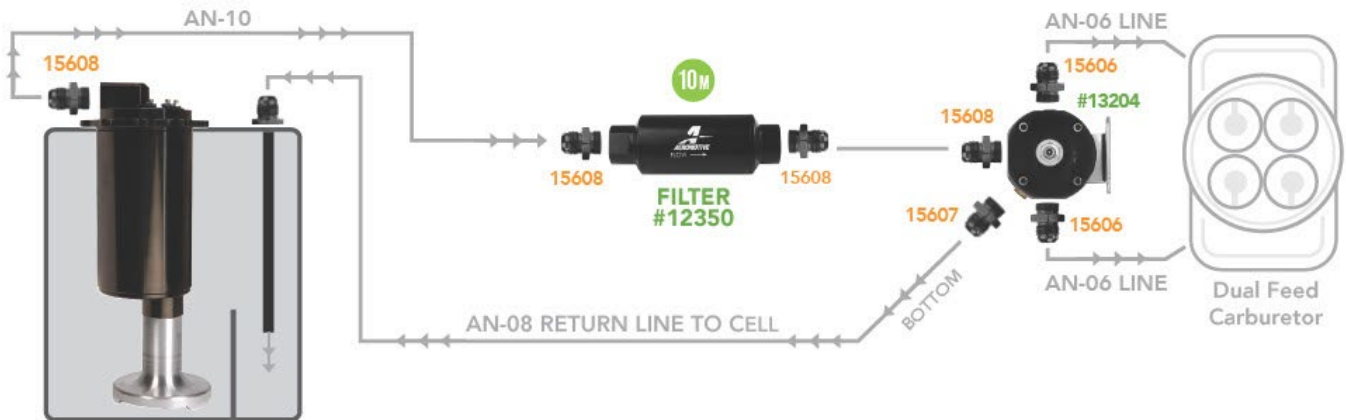

# BRUSHLESS ELIMINATOR IN-TANK Dual Feed Carbureted

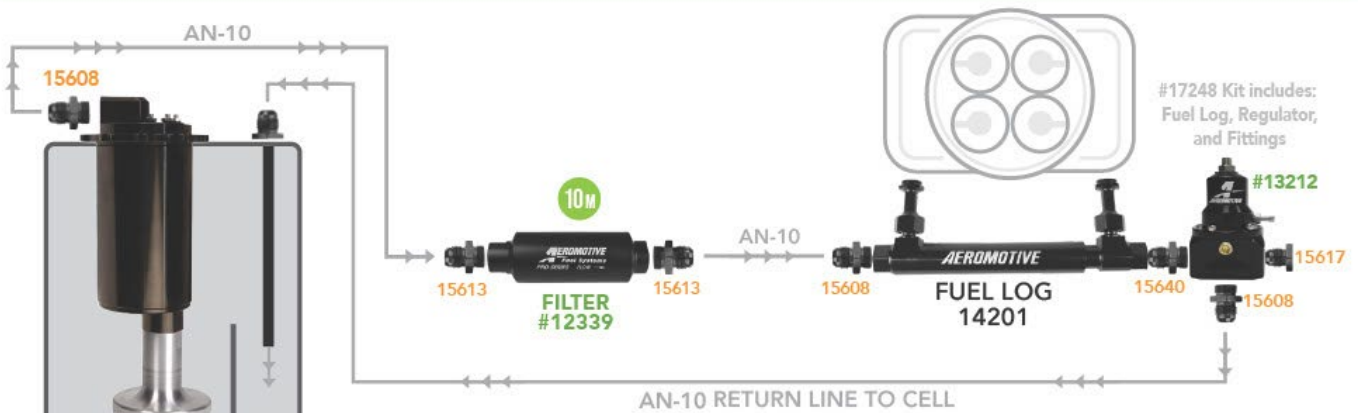

**Note: Be sure to route all electrical wires clear of any moving suspension or drivetrain components and any exhaust components! Protect wires from abrasion and road obstructions or debris.**

6. Connect the return port on the fuel pressure regulator to the AN-08 Port on the Aeromotive Stealth Fuel Cell as in the above diagrams.
7. Determine a suitable location to mount the controller remote from the pump considering the following:
  - a) It is recommended to keep the controller-to-motor lead wire lengths as short as possible for best pump performance.
  - b) If desired, motor lead extensions can be used but should be kept as short as possible and lead extensions should be sized large to keep electrical resistance low (you may even want to use a larger size for the extensions than the provided leads for long extensions).

- c) The controller is fully sealed so it can be mounted externally (frame rail, e.g.). The controller sink is designed to be able to handle low air flow so it can also be mounted internally (trunk, e.g.). However, for best results, it is recommended to mount the controller such that it will receive the most and coolest air flow.

When mounting the controller externally and in a location that will likely receive air flow from driving, mount the controller with fins parallel to the airflow and, if possible, upward (not required with sufficient air flow) as in the following image.

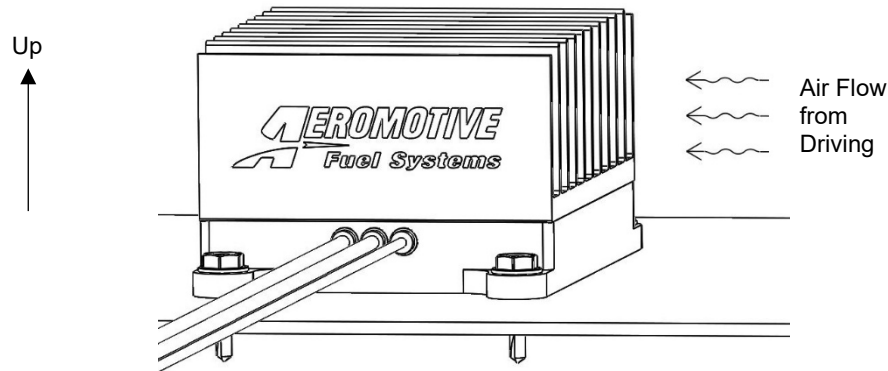

When mounting the controller internally or behind obstructions in a location that will not receive much air flow from driving, mount the controller with the fins vertically as in the following image to achieve the maximum natural convective cooling.

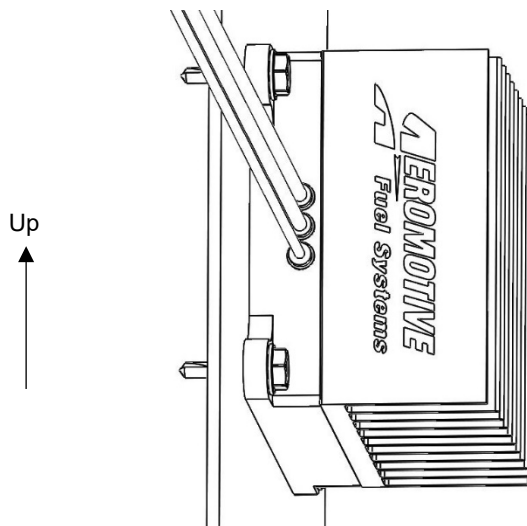

- d) **NOTE: THIS CONTROLLER CAN GET HOT** when using full power (60A rating) continuously with little air flow. **Mount away from locations prone to fuel vapor (e.g., tank vent).**
8. Once a suitable location is found, mount the controller in the recommended orientation using the four #10 self-drilling screws.
  9. Crimp the #10 ring terminals to the motor lead wires after cutting to length if not using extensions.
  10. Connect the three motor leads from the controller to the pump matching the colors to the engravings (In most cases, the black lead connects to the “B”, red to “R”, and white/gray to “W”). Secure connections using the #10-32 nuts installed on the pump outlet cap, firmly holding the terminal end in place while tightening.
  11. Connect the fuel pump as shown in the following diagram, +12VDC to the red lead, Ground to the black lead. To make installation easier, a kit is available, Aeromotive fuel pump wiring kit, part # 16307. **NOTE: POWER TO THE PUMP MUST BE FLAT DC, NOT PULSE WIDTH MODULATED!**

**CAUTION: DO NOT REVERSE THE POLARITY-CONNECT AS STATED ABOVE. Reversing the polarity will render the controller inoperable and will void all warranties for this product!**

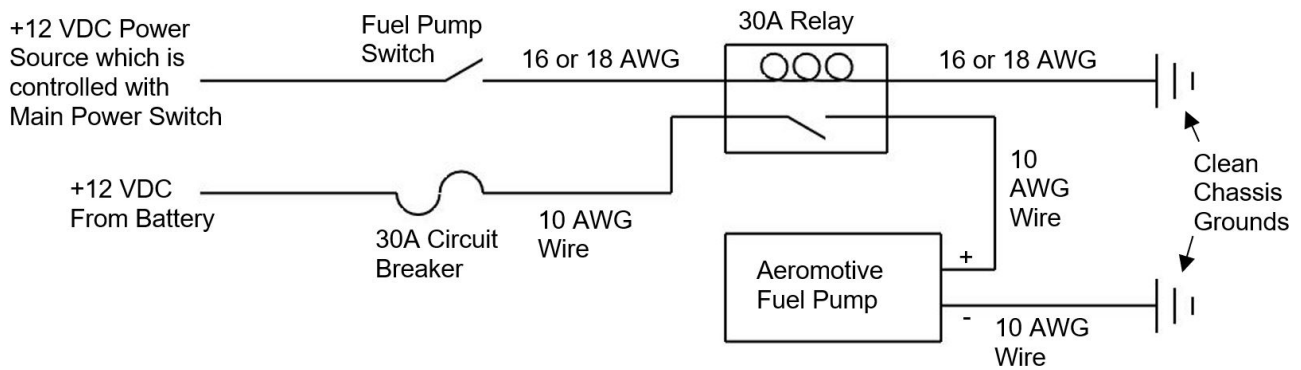

12. This pump controller allows the ability to change the speed of the pump via a 0-5VDC analog input to the yellow signal wire. **THE CONTROL SIGNAL MUST BE A TRUE ANALOG INPUT, NOT PWM.** A PWM signal can only be used if filtered sufficiently for smooth operation. The signal wire used to control the speed of the pump may be connected in ONE of multiple configuration examples as shown in the following illustrations to control the speed of the pump.
13. This pump controller has a minimum floor for pump speed of approximately 40% depending on the pump. This means that fuel pump speed will not fall below 40% of full speed with zero input voltage on the yellow control signal wire.
14. This pump controller has a minimum voltage threshold of approximately 0.5VDC. Voltage above 0.5VDC on the yellow input wire will increase the speed of the pump. Signal input of voltage below 0.5VDC will have no effect on pump speed. This ensures allowance for minimum, closed throttle TPS settings of up to 0.5VDC without affecting fuel pump speed at idle.
15. This pump controller has a full pump speed voltage threshold of approximately 3.7VDC, where the full pump speed will be achieved with signal input voltage at or above 3.7VDC and above which no further change in pump speed will occur. This ensures that when a TPS signal is used to drive pump speed that typical throttle openings of 70-75% and higher will ensure full fuel pump volume is delivered to the fuel rail or carburetor. Voltage between 0.5VDC and 3.7VDC will vary the speed of the fuel pump according to the voltage applied.

#### CONTROL CONFIGURATIONS:

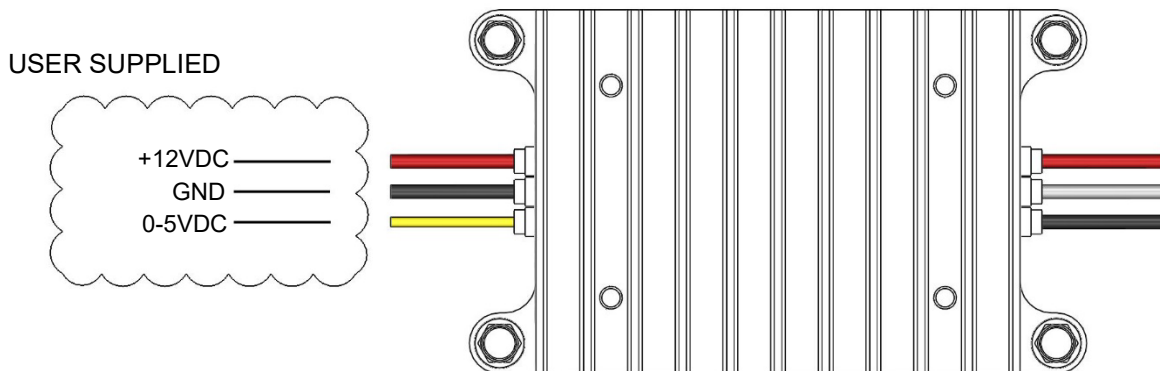

MODE 1 – TPS or Other 0-5VDC Input Control

Aeromotive recommends the “Mode 1” control method where the 0-5VDC signal input is tied to a Throttle Position Sensor using the output wire to the ECU. The intent for this control is to reduce the fuel pump output (and thus the amount of returned fuel flow) during low throttle opening (low engine demand) to reduce excess recycling of fuel to help keep fuel tank temperatures low. Alternatively, other 0-5VDC analog output sensors (some MAF sensors, a 2 or 3-Bar MAP sensor, etc.) or voltage dividing/regulating/switching components may be used. It is the customer’s responsibility to ensure a signal supply and control strategy where the fuel flow is sufficient to meet engine demand.

If no signal supply is suitable or desired, the controller can still be wired for use as in Modes 2 – 4, as shown following, to allow different fuel pump speed and flow outputs from the pump.



USER SUPPLIED

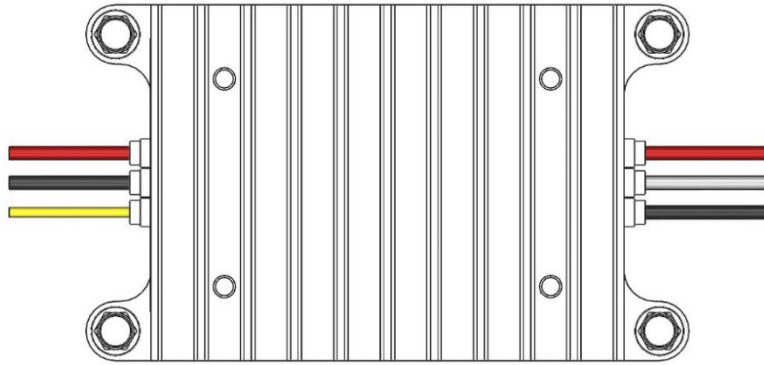
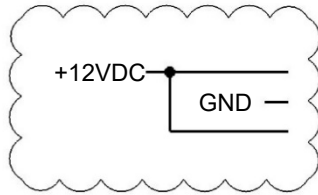

MODE 2 – Constant Full Speed

USER SUPPLIED

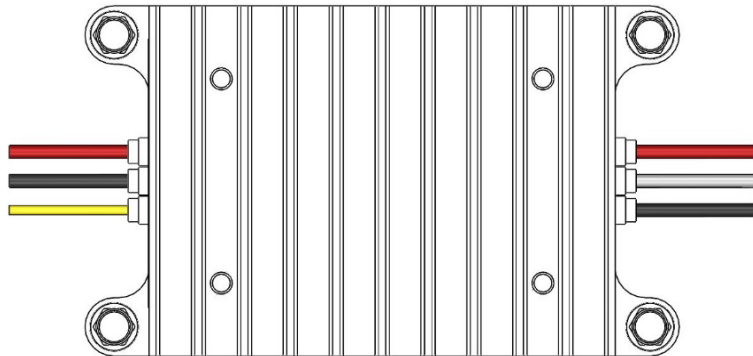
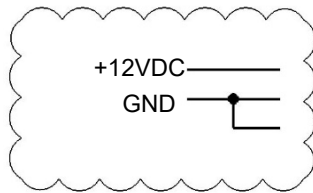

MODE 3 – Constant Low Speed

USER SUPPLIED

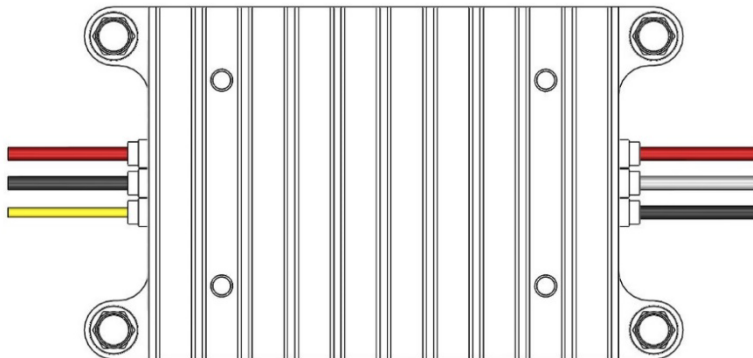
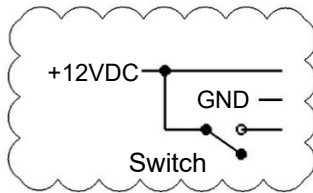

MODE 4 – Switched Speed On - Demand from Low to High

Mode 4 can be activated by any relay or switch providing 5VDC or higher (system voltage up to 19VDC is fine) to the control wire. A relay for this purpose could be activated using the programmable output from a tunable ECU, or via a boost Hobb's or WOT switch connected to 12VDC to name a few examples.

16. Connect the fuel sending unit output wire (not used on 6 gallon cells) to a 0-90 ohm compatible fuel level gauge. 0 ohms reads empty, and 90 ohms reads full.
17. After all wire connections are made, attach a suitable fuel pressure gauge to the fuel system Schrader valve, fuel rail or fuel pressure regulator.  
**P/N 15632** 0-15 PSI (1 1/2") Fuel Pressure Gauge  
**P/N 15633** 0-100 PSI (1 1/2") Fuel Pressure Gauge

**Ensure that any spilled fuel and any fuel-soaked shop towels are cleaned up and removed from the vicinity of the vehicle.**



***CAUTION: If any fuel leaks are detected, immediately turn the ignition to OFF, remove any spilled fuel and repair the leak(s) before proceeding!***

18. Turn the ignition to ON **without starting the engine**, allow the pump to run for several seconds and check the fuel pressure. If there is no pressure, turn the ignition to OFF, wait one minute, then turn the ignition to ON and recheck the pressure. Repeat this ignition OFF and ON procedure until the gauge registers pressure or you detect a fuel leak. If no pressure is registered on the gauge after running the pump for several seconds and you have found no leaks, check all fuel and electrical connections to determine the cause.
19. Once the fuel pressure gauge registers pressure, start the engine. If you have installed an adjustable fuel pressure regulator, adjust it to the desired setting.
20. Shut the engine off. Using suitable clips and other mounting hardware, secure the newly installed fuel lines and electrical wires by attaching them to the vehicle chassis.
21. Test-drive the vehicle to insure proper operation and re-check the fuel system for leaks. **If any leaks are found, immediately discontinue use of the vehicle and repair the leak(s)!**

# Contact Us

RGA NUMBER REQUIRED FOR ALL RETURNS TO AEROMOTIVE.

To obtain an RGA number, please call (913) 647-7300 and ask for the Returns and Repairs department or complete the online form under the "Rebuilds" section at [www.aeromotiveinc.com](http://www.aeromotiveinc.com).

- **Shipping & Returns**  
Aeromotive Inc.  
11414 W 79th Street.  
Lenexa, KS 66214

**General Inquiries and Tech Line:** (913) 647-7300

**General Email:** [info@aeromotiveinc.com](mailto:info@aeromotiveinc.com)

**Tech Email:** [tech@aeromotiveinc.com](mailto:tech@aeromotiveinc.com)

*The Aeromotive Tech Lines are open Monday through Friday from 9:30AM to 5:00PM Central Standard Time.*



**WARNING:** This product can expose you to chemicals, including chromium, which is known to the State of California to cause cancer or birth defects or other reproductive harm. For more information, visit: [www.p65Warnings.ca.gov](http://www.p65Warnings.ca.gov)

### ***AEROMOTIVE, INC. LIMITED WARRANTY***

This Aeromotive Product, with proof of purchase dated on or after January 1, 2003, is warranted to be free from defects in materials and workmanship for a period of one year from the original date of purchase. No warranty claim will be valid without authentic, dated proof of purchase.

This warranty is to the original retail purchaser and none other and is available directly from Aeromotive and not through any point of distribution or purchase.

If a defect is suspected, the retail purchaser must contact Aeromotive directly to discuss the problem, possible solutions and obtain a Return Goods Authorization (RGA), if deemed necessary by the company. Please call 913-647-7300 and dial option 3 for the technical service dept. All returns must be shipped freight pre-paid to the company and with valid RGA before they will be processed.

Aeromotive will examine any product returned with the proper authorization to determine if the failure resulted from a defect or from abuse, improper installation, misapplication or alteration. Aeromotive will then, at it's sole discretion, return, repair or replace the product.

If any Aeromotive product is determined defective, buyer's exclusive remedy is limited in value to the sale price of the good. In no event shall Aeromotive be liable for incidental or consequential damages.

Aeromotive expressly retains the right to make changes and improvements in any product it manufactures and sells at any time. These changes and improvements may be made without notice at any time and without any obligation to change the catalogs or printed materials.

Aeromotive expressly retains the right to discontinue at any time and without notice any Aeromotive product that it manufactures or sells.

This warranty is limited and expressly limits any implied warranty to one year from the date of the original retail purchase on all Aeromotive products.

No person, party or corporate entity other than Aeromotive shall have the right to: determine whether or not this Limited Warranty is applicable to any Aeromotive product, authorize any action whatsoever under the terms and conditions of this Limited Warranty, assume any obligation or liability of any nature whatsoever on behalf of Aeromotive under the terms and conditions of this Limited Warranty.

This Limited Warranty covers only the product itself and not the cost of installation or removal.

This Limited Warranty is in lieu of and expressly excludes any and all other warranties, expressed or implied. This Limited Warranty gives you specific legal rights, and you may also have other rights which vary from state to state.