

Installation Instructions

I-Sheet Number 10369 Rev. B





ATV TOOLBOX

For proper installation and best possible fit, please read all instructions **BEFORE** you begin.

For technical assistance or to obtain missing parts, please call Customer Relations at **1-800-241-7219**.

Important Safety Information

-  **WARNING**
 - Periodically check all components for tightness.
-  **CAUTION**
 - Be sure to wear safety glasses while installing toolbox.
 - When using power tools read and understand all operating instructions.

Contents

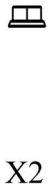
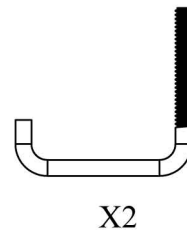
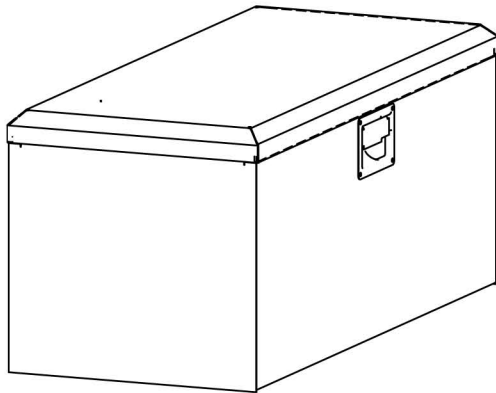

Tools Required

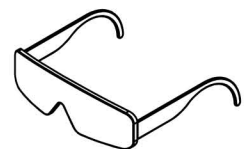
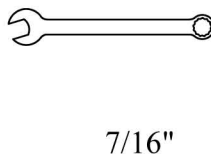
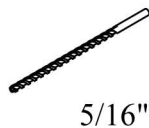
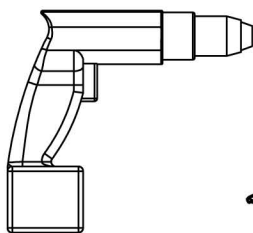

Installation Steps

I-10369

1. Position toolbox on rack, check for handlebar clearance on front box.

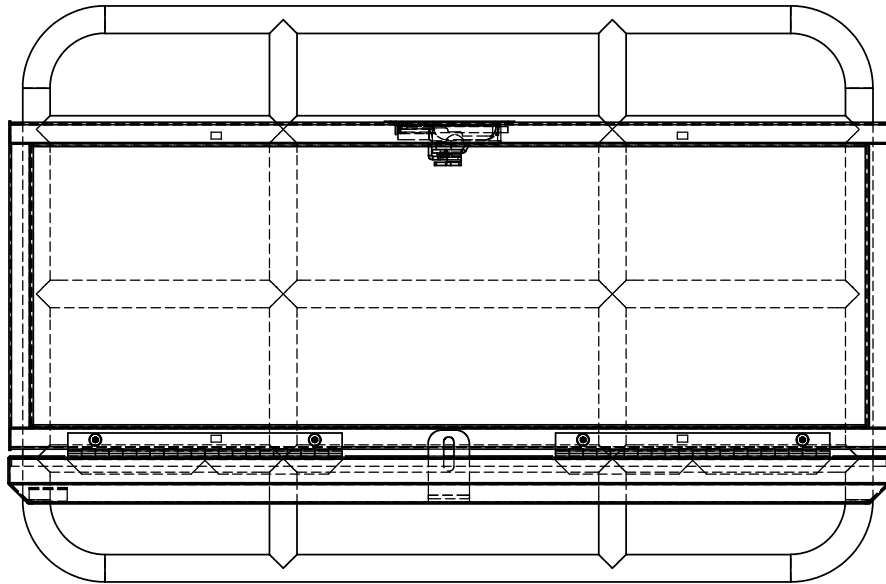

1

Top View

2. Mark bottom of of box for J-hooks.

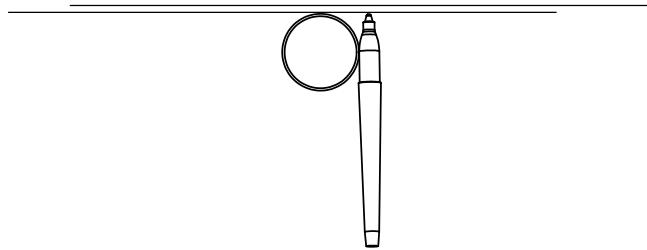

2

3. Drill two 5/16" holes for J-bolts

4. Install J-bolts, tighten nuts.

5. Trim excess thread if desired.

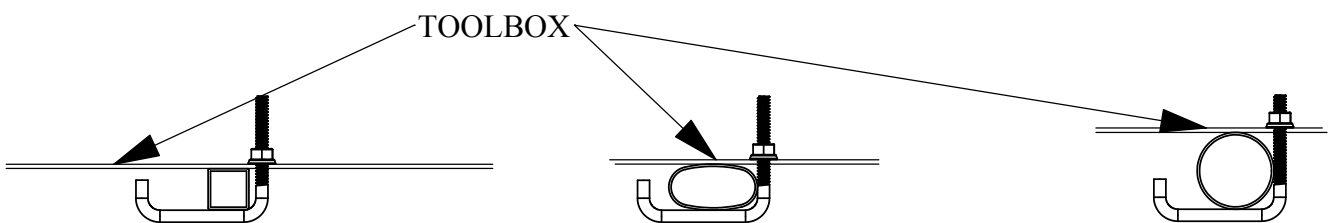
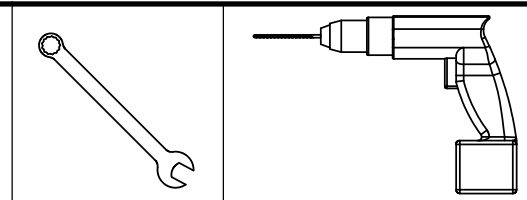

3

TYPICAL INSTALLATIONS

Congratulations

You have purchased one of the many quality products offered by Lund. We take the utmost pride in our products and want you to enjoy years of satisfaction from your investment. We have made every effort to ensure that your product is top quality in terms of fit, durability, finish and ease of installation.

LUND®

Lund International

800-241-7219 • Visit us at lundinternational.com

© 2012 Lund International, Inc. All rights reserved.

Lund® and the Lund® logo are trademarks of Lund International, Inc.



Instrucciones de instalación

I-Sheet Number 10369 Rev. B

LUND ATV TOOLBOX

Recomendamos leer las instrucciones antes de comenzar para lograr una instalación correcta y precisa.

Si necesita asistencia técnica o desea solicitar piezas faltantes, comuníquese con el departamento de atención al cliente al **1-800-241-7219**.

Información importante de seguridad



Advertencia

- Revise con regularidad que los componentes se encuentren bien ajustados.



Precaución

- Utilice lentes de seguridad cuando instale el sistema de soportes EZ de Lund.
- Antes de utilizar herramientas eléctricas lea las instrucciones de uso.

Contenido

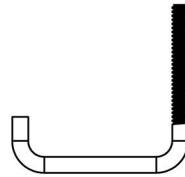
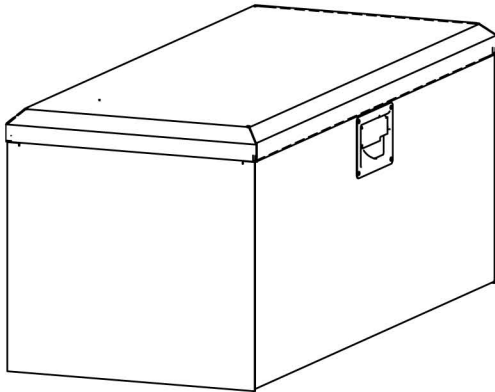

X2



X2

Herramientas Necesarias

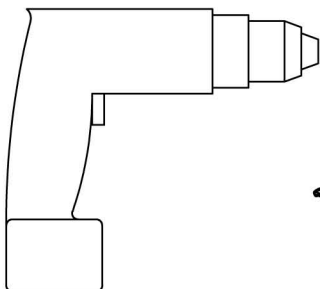

5/16"

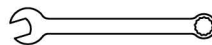

7/16"

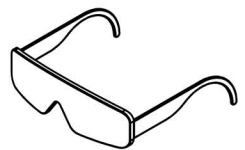

1. Coloque la caja de herramientas en el estante, compruebe para saber si hay separación del manillar en la caja delantera

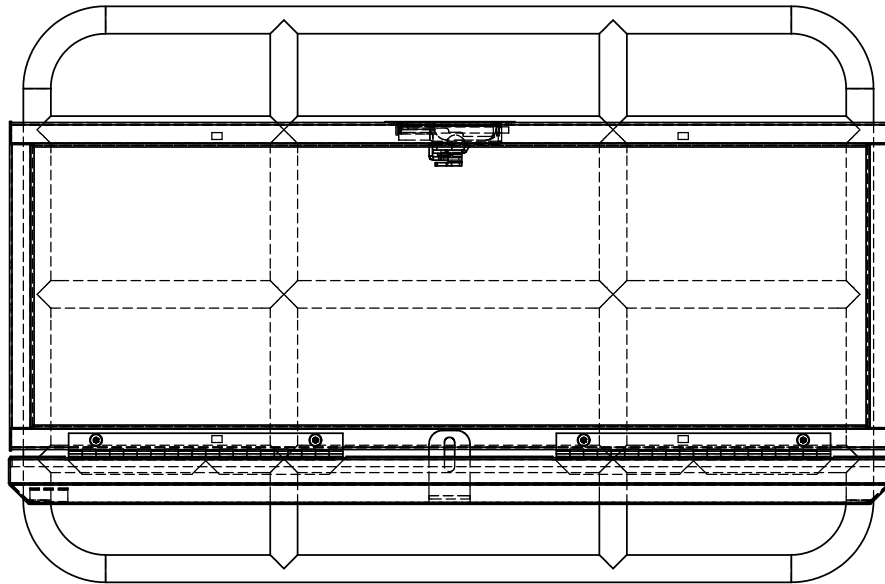

1

Tapa Visión

2. Marque el fondo de la caja para los j-hooks.

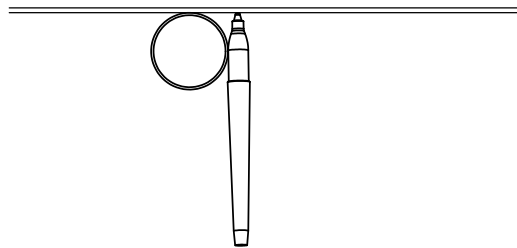

2

3. Agujeros del taladro dos el 5/16" para los j-bolts
4. Instale Los J-bolts, apriete las tuercas.
5. Exceso de hilo de rosca del ajuste si está deseado.

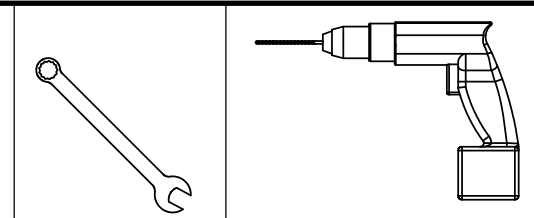

3

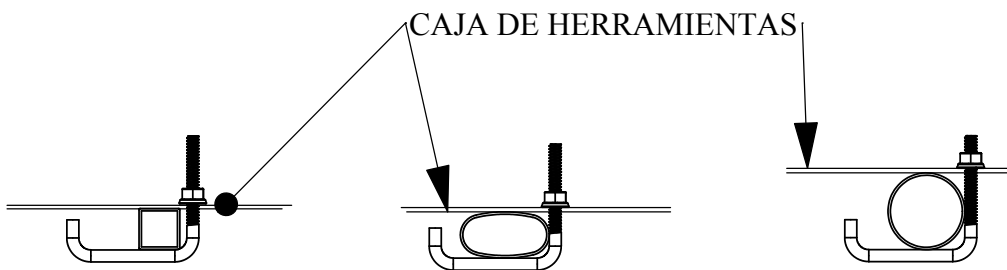

Felicitaciones

Ha adquirido uno de los productos de la extensa línea de gran calidad de Lund. Nos enorgullece enormemente ofrecerle nuestros productos y deseamos que disfrute su inversión durante muchos años. Hemos realizado todos los esfuerzos pertinentes para garantizar que el ajuste, durabilidad, acabado y facilidad de instalación del producto sean de la más alta calidad.

LUND®

Lund International

800-241-7219 • Visite nuestro sitio Web: lundinternational.com

© 2012 Lund International, Inc. Todos los derechos reservados.

Lund® y el logo de Lund® son marcas registradas de Lund International, Inc.



Instructions d'installation

I-Sheet Number 10369 Rev. B

LUND®

ATV TOOLBOX

Pour assurer la meilleure installation possible, veuillez lire les instructions AVANT de commencer.

Pour toute assistance technique ou en cas de pièce manquante, communiquez avec le service des relations avec les clients au 1-800-241-7219.

L'Information Importante De Sûreté

- ⚠ Attention • Vérifier régulièrement que tous les composants sont bien serrés.
- ⚠ Avertissements • Toujours porter des lunettes de sécurité pour installer le support EZ de Lund.
• Avant de se servir d'outils électriques, lire attentivement toutes les consignes d'utilisation.

Contenus

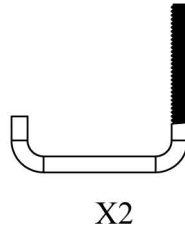
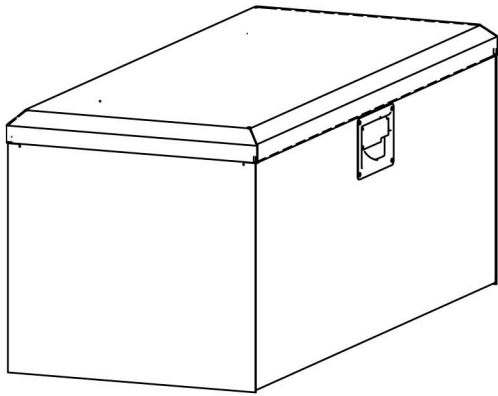

Outillage Requis

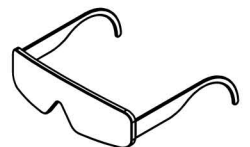
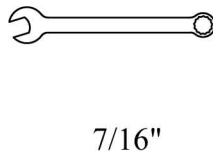
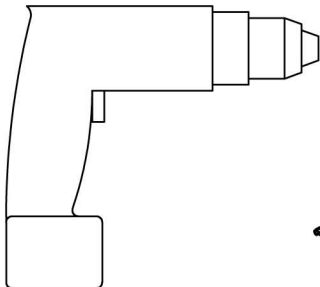

1. Placez la boîte à outils sur le support, vérifiez le dégagement de guidon sur la boîte avant.

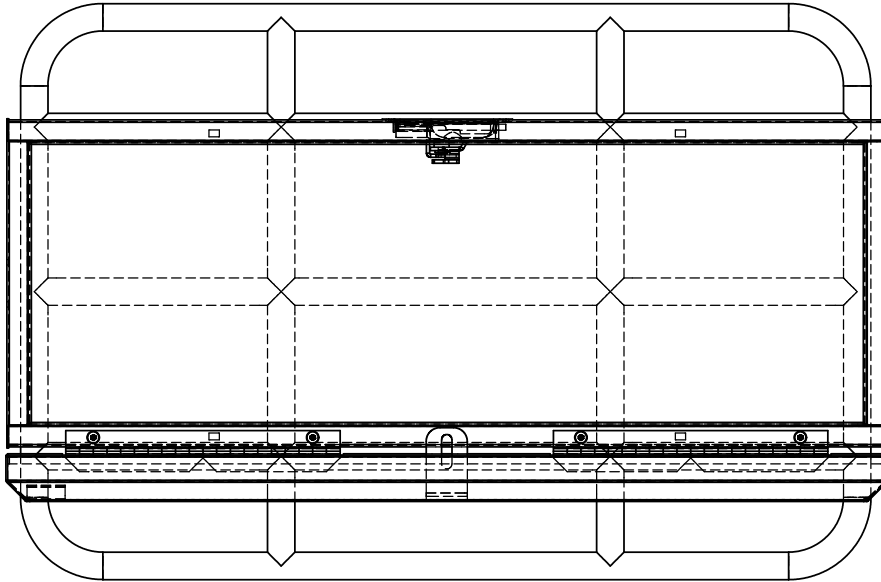

Vue Dessus

1

2. Marquez le fond de de la boîte pour des crochets en J.

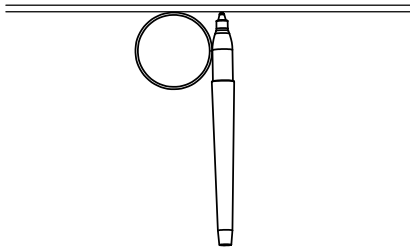

2

- 3. Trous du foret deux 5/16" pour des boulons en J
- 4. Installez Les Boulons en J, serrez les écrous.
- 5. Fil excessif d'équilibre si désiré.

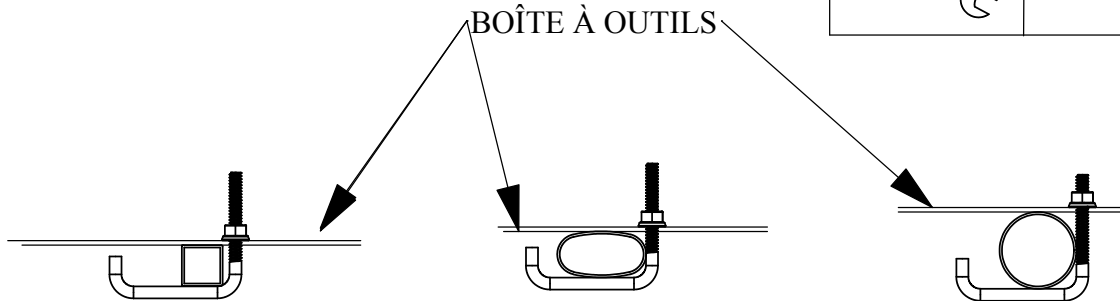
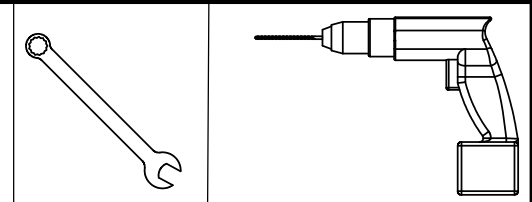

3

Félicitations

Vous venez d'acheter un des nombreux produits de qualité offerts par Lund. Nous sommes très fiers de nos produits et espérons que cet investissement vous donnera satisfaction pendant de nombreuses années.

Nous avons fait tout en notre pouvoir pour nous assurer que votre produit est de la meilleure qualité qui soit tant en termes d'ajustement, de durabilité, de finition que de facilité d'installation.

LUND®

Lund International

800-241-7219 • Visitez notre site lundinternational.com

© 2012 Lund International, Inc. Tous droits réservés.

Lund® et le logo Lund® sont des marques déposées de Lund International, Inc.

